

Heater series
NKV



■ **Applications**

Duct water heaters are designed for heating of supply air in rectangular ventilating system and are applicable in supply or supply and exhaust units.

■ **Design**

The heater casing is made of galvanized steel, the manifold is made of copper tubes and the heat exchange surface is made of aluminium plates. The heaters are available in 2, 3 or 4 rows modifications and designed for operation at maximum operating pressure 1,6 MPa (16 bar) and maximum operating temperature +100°C. The exhaust manifold of the heater has a branch pipe for submersible temperature sensor or icing protecting device. The heater has a nipple to provide the system deaeration.

■ **Mounting**

- ▶ The heater design ensures its mounting by means of a flange connection. The water heater can be installed in any position to enable its deaeration. The air stream shall match the pointer on the heater;
- ▶ The heater shall be installed in such a way as to enable the uniform air distribution along the entire cross section;
- ▶ the air filter shall be installed at the heater inlet to provide protection against dust and dirt;
- ▶ the heater can be installed both at the fan inlet or outlet. If the heater is located at the fan outlet the air duct length between the heater and the fan shall be at least 1-1.5 m to ensure the air flow stabilization as well as permissible air temperature level inside the fan;
- ▶ The heater shall be connected on the counterflow principle, otherwise its efficiency can drop by 5-15%. All the nomographic charts in the catalogue are valid for such connection;

- ▶ If water serves as a heat transfer agent the heaters are designed for indoor installation only. For outdoor installation use antifreeze mixture (i.e. ethylene glycol solution);
- ▶ To ensure the correct and safe heater operation use the automation system that provides the complex control and freezing protection:
 - ✓ automatic control of heating elements capacity and air heating temperature;
 - ✓ Switching ventilating system on with preliminary heating by the heater;
 - ✓ use of air curtains equipped with spring-loaded actuator;
 - ✓ filter checking by means of differential pressure sensor;
 - ✓ fan shutdown in case of water coils freezing danger.

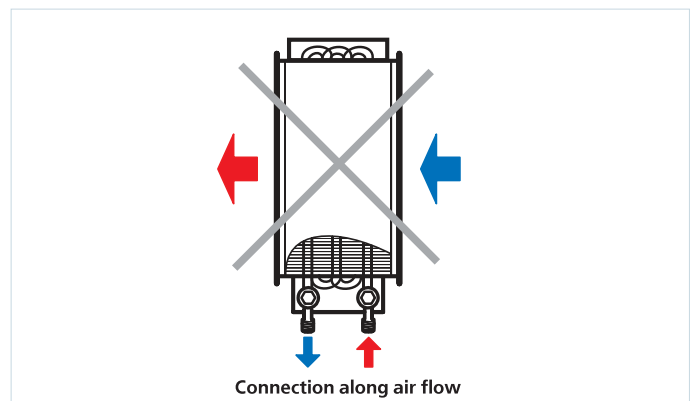
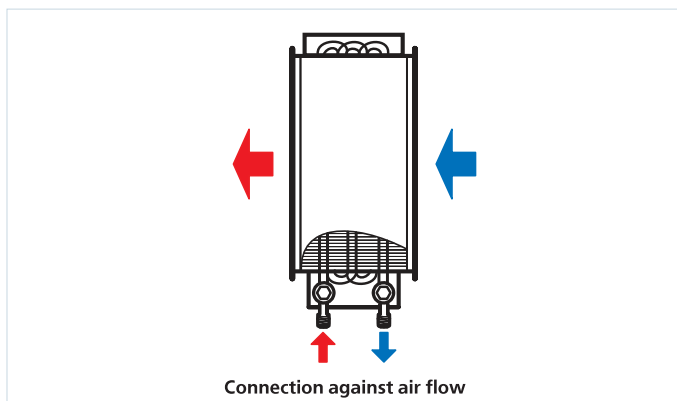

Designation key:

Series	Flange designation (WxH) [mm]	Number of water coil rows
NKV	400x200; 500x250; 500x300; 600x300; 600x350; 700x400; 800x500; 900x500; 1000x500	2; 3; 4

Accessories



page 322

Overall dimensions:

Type	Dimensions [mm]												Number of water coil rows	Mass [kg]
	B	B1	B2	B3	H	H1	H2	H3	L	L1	L2	K		
NKV 400x200-2	400	420	440	565	200	220	240	150	200	43	43	G 3/4"	2	7,6
NKV 400x200-4	400	420	440	565	200	220	240	150	200	38	65	G 3/4"	4	8,1
NKV 500x250-2	500	520	540	665	250	270	290	200	200	43	43	G 3/4"	2	15,8
NKV 500x250-4	500	520	540	665	250	270	290	200	200	38	65	G 3/4"	4	16,3
NKV 500x300-2	500	520	540	665	300	320	340	250	200	43	43	G 1"	2	11,5
NKV 500x300-4	500	520	540	665	300	320	340	250	200	38	65	G 1"	4	12,0
NKV 600x300-2	600	620	640	765	300	320	340	250	200	43	43	G 1"	2	21,8
NKV 600x300-4	600	620	640	765	300	320	340	250	200	38	65	G 1"	4	22,3
NKV 600x350-2	600	620	640	765	350	370	390	300	200	43	43	G 1"	2	22,4
NKV 600x350-4	600	620	640	765	350	370	390	300	200	38	65	G 1"	4	22,9
NKV 700x400-2	700	720	740	865	400	420	440	350	200	36	47	G 1"	2	27,8
NKV 700x400-3	700	720	740	865	400	420	440	350	200	42	58	G 1"	3	28,4
NKV 800x500-2	800	820	840	965	500	520	540	450	200	36	47	G 1"	2	36,5
NKV 800x500-3	800	820	840	965	500	520	540	450	200	42	58	G 1"	3	37,2
NKV 900x500-2	900	920	940	1065	500	520	540	450	200	36	47	G 1"	2	40,4
NKV 900x500-3	900	920	940	1065	500	520	540	450	200	42	58	G 1"	3	41,2
NKV 1000x500-2	1000	1020	1040	1165	500	520	540	450	200	36	47	G 1"	2	44,3
NKV 1000x500-3	1000	1020	1040	1165	500	520	540	450	200	42	58	G 1"	3	45,2

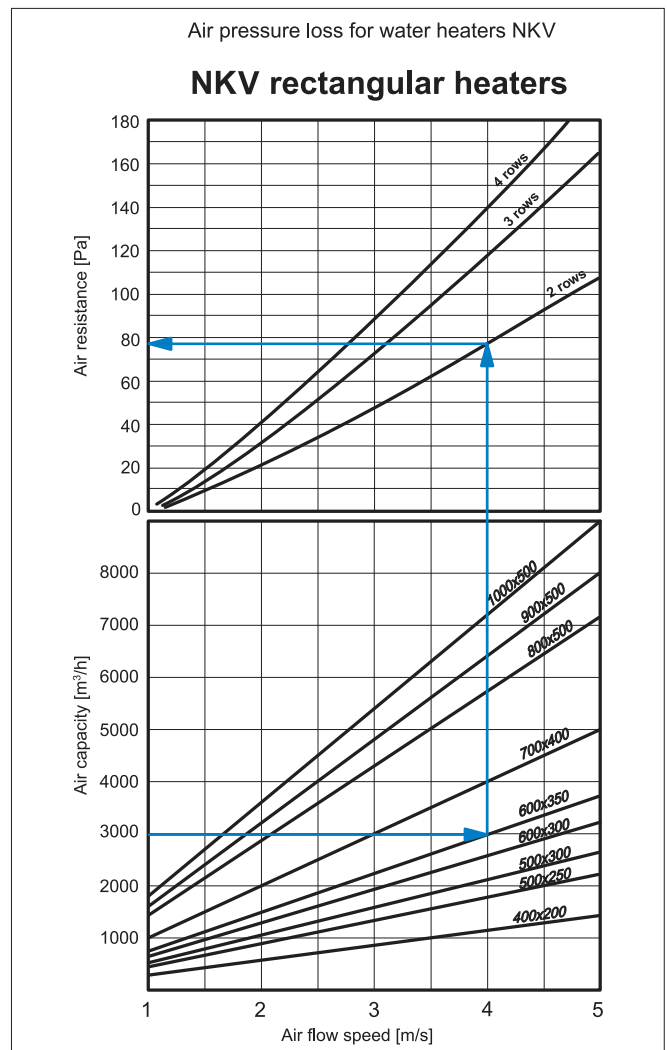
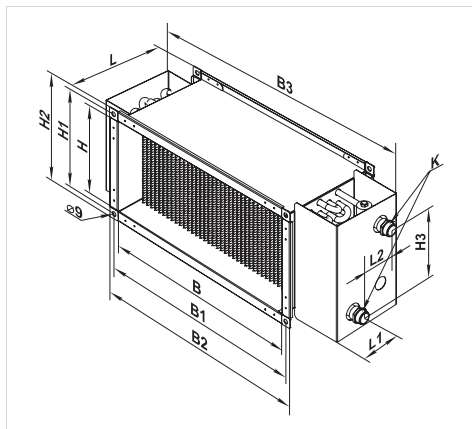

NKV

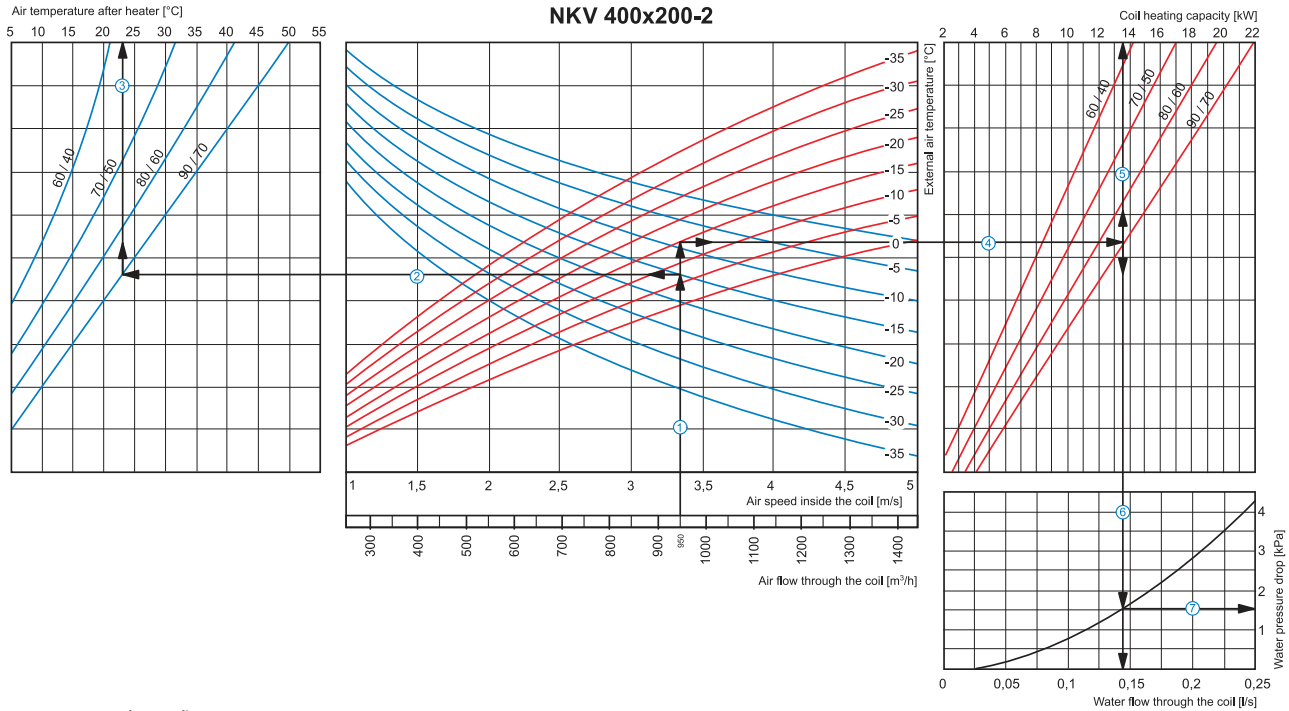

How to use water heater diagrams

Air Speed. Starting from 950 m³/h on the air flow scale draw a vertical line ① till the air speed axis which makes about 3.35 m/s.

- **Supply air temperature.** Prolong the line ① up to the point where it crosses the outside air temperature (blue curve), e.g. -15°C; then draw a horizontal line ② from this point to the left till crossing water in/out temperature curve (90/70 °C). From this point draw a vertical line ③ to the supply air temperature axis on top of the graphic (+23°C).
- **Heating coil capacity.** Prolong the line ① up to the point where it crosses the outside air temperature indicated as red curve (e.g., -15°C) and draw a horizontal line ④ from this point to the right to the intersection of water in/out temperature curve (e.g., 90/70 °C). From this point draw a vertical line ⑤ up to the scale of heating coil capacity (13.5 kW).
- **Water flow.** Prolong the line ⑥ down to water flow axis at the bottom of the graphic (0.14 l/s).
- **Water pressure drop.** Draw the line ⑦ from the point where line ⑥ crosses the black curve to the pressure drop axis. (1.5 kPa).

NKV

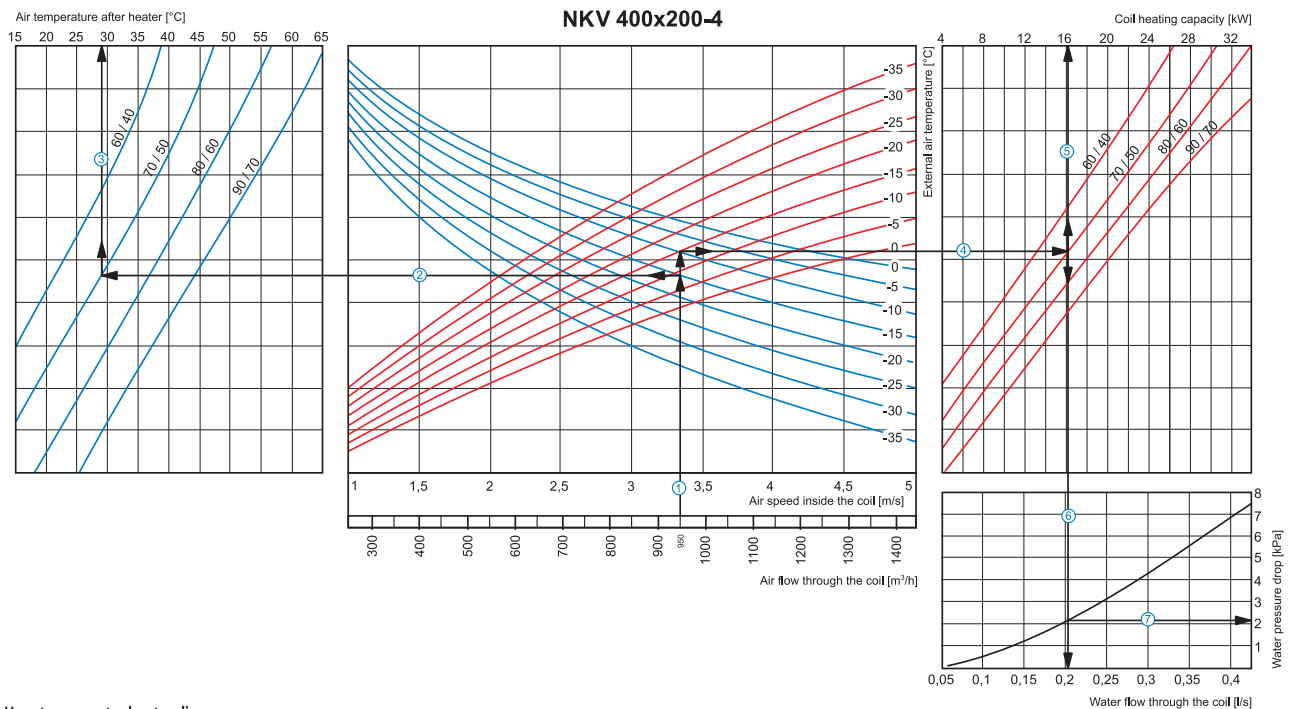

How to use water heater diagrams

Air Speed. Starting from 950 m³/h on the air flow scale draw a vertical line ① till the air speed axis which makes about 3.35 m/s.

- **Supply air temperature.** Prolong the line ① up to the point where it crosses the outside air temperature (blue curve), e.g. -15°C; then draw a horizontal line ② from this point to the left till crossing water in/out temperature curve (70/50 °C). From this point draw a vertical line ③ to the supply air temperature axis on top of the graphic (+29°C).
- **Heating coil capacity.** Prolong the line ① up to the point where it crosses the outside air temperature indicated as red curve (e.g., -15°C) and draw a horizontal line ④ from this point to the right to the intersection of water in/out temperature curve (e.g., 70/50 °C). From this point draw a vertical line ⑤ up to the scale of heating coil capacity (16.0 kW).
- **Water flow.** Prolong the line ⑥ down to water flow axis at the bottom of the graphic ⑥ (0.2 l/s).
- **Water pressure drop.** Draw the line ⑦ from the point where line ⑥ crosses the black curve to the pressure drop axis. (2.1 kPa).

NKV

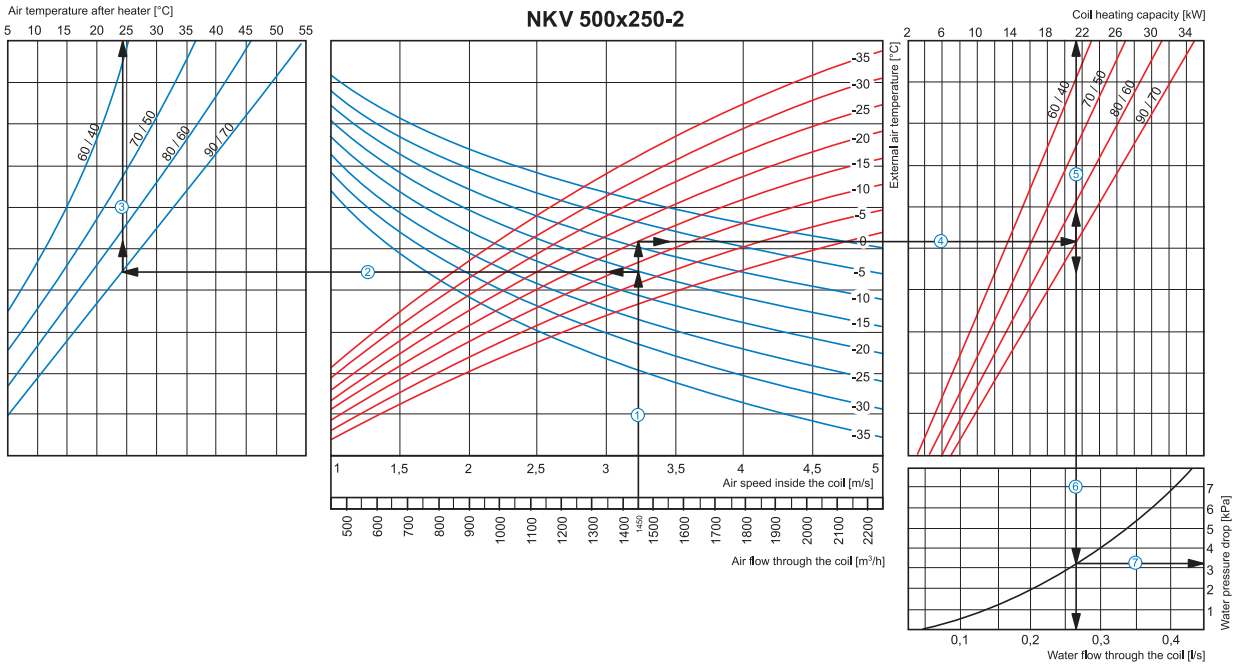

How to use water heater diagrams

Air Speed. Starting from 1450 m³/h on the air flow scale draw a vertical line ① till the air speed axis which makes about 3.2 m/s.

■ **Supply air temperature.** Prolong the line ① up to the point where it crosses the outside air temperature (blue curve), e.g. -15°C; then draw a horizontal line ② from this point to the left till crossing water in/out temperature curve (90/70 °C). From this point draw a vertical line ③ to the supply air temperature axis on top of the graphic (+24°C).

■ **Heating coil capacity.** Prolong the line ① up to the point where it crosses the outside air temperature indicated as red curve (e.g., -15°C) and draw a horizontal line ④ from this point to the right till the intersection of water in/out temperature curve (e.g., 90/70 °C). From this point draw a vertical line ⑤ up to the scale of heating coil capacity (21.5 kW).

■ **water flow.** Prolong the line ⑤ down to water flow axis at the bottom of the graphic ⑥ (0.27 l/s).

■ **Water pressure drop.** Draw the line ⑦ from the point where line ⑥ crosses the black curve to the pressure drop axis. (3.2 kPa).

NKV

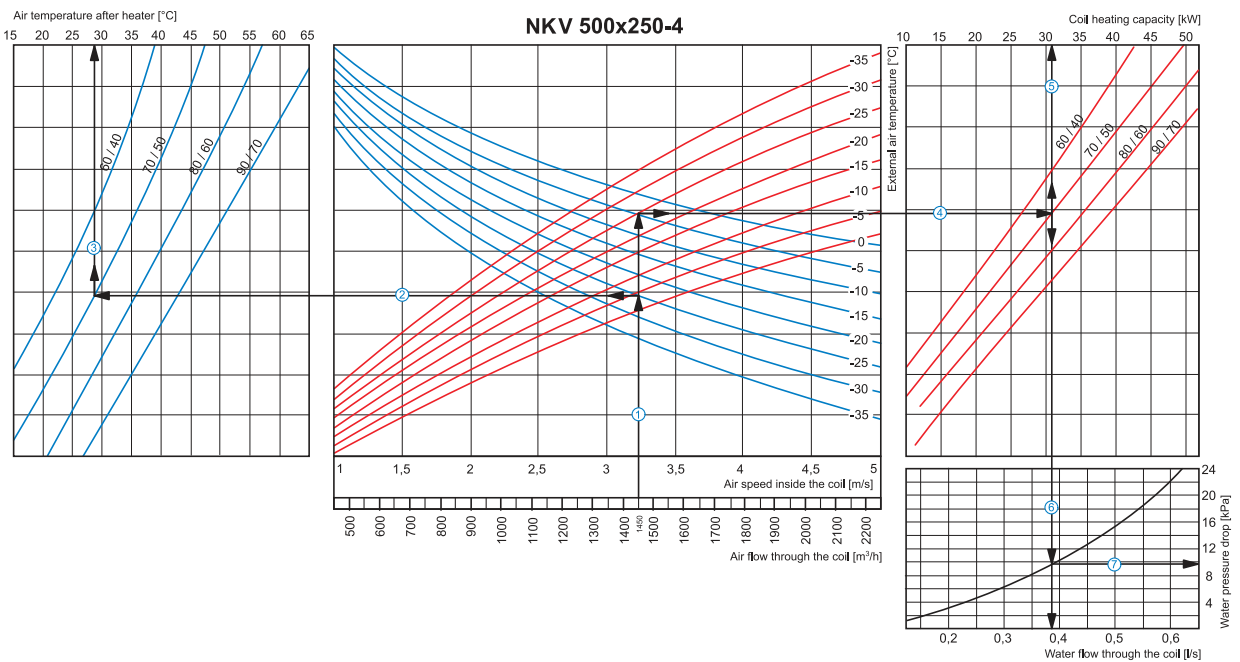

How to use water heater diagrams

Air Speed. Starting from 1450 m³/h on the air flow scale draw a vertical line ① till the air speed axis which makes about 3.2 m/s.

■ **Supply air temperature.** Prolong the line ① up to the point where it crosses the outside air temperature (blue curve), e.g. -25°C; then draw a horizontal line ② from this point to the left till crossing water in/out temperature curve (70/50 °C). From this point draw a vertical line ③ to the supply air temperature axis on top of the graphic (+28°C).

■ **Heating coil capacity.** Prolong the line ① up to the point where it crosses the outside air temperature indicated as red curve (e.g., -25°C) and draw a horizontal line ④ from this point to the right till the intersection of water in/out temperature curve (e.g., 70/50 °C). From this point draw a vertical line ⑤ up to the scale of heating coil capacity (31.0 kW).

■ **water flow.** Prolong the line ⑤ down to water flow axis at the bottom of the graphic ⑥ (0.38 l/s).

■ **Water pressure drop.** Draw the line ⑦ from the point where line ⑥ crosses the black curve to the pressure drop axis. (9.8 kPa).

NKV

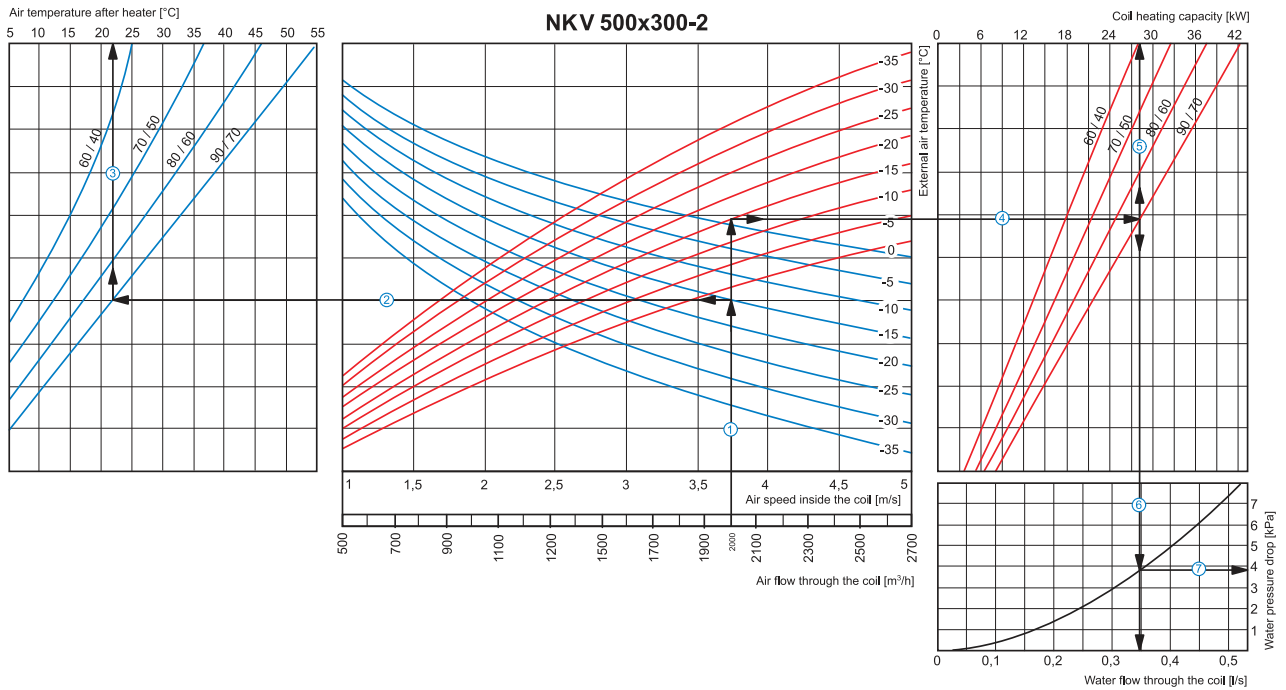

How to use water heater diagrams

Air Speed. Starting from 2000 m³/h on the air flow scale draw a vertical line ① till the air speed axis which makes about 3.75 m/s.

Supply air temperature. Prolong the line ① up to the point where it crosses the outside air temperature (blue curve), e.g. -15°C; then draw a horizontal line ② from this point to the left till crossing water in/out temperature curve (90/70 °C). From this point draw a vertical line ③ to the supply air temperature axis on top of the graphic (+22°C).

Heating coil capacity. Prolong the line ① up to the point where it crosses the outside air temperature indicated as red curve (e.g., -15°C) and draw a horizontal line ④ from this point to the right to the intersection of water in/out temperature curve (e.g., 90/70 °C). From this point draw a vertical line ⑤ up to the scale of heating coil capacity (28.0 kW).

Water flow. Prolong the line ⑤ down to water flow axis at the bottom of the graphic ⑥ (0.35 l/s).

Water pressure drop. Draw the line ⑦ from the point where line ⑥ crosses the black curve to the pressure drop axis. (3.8 kPa).

NKV

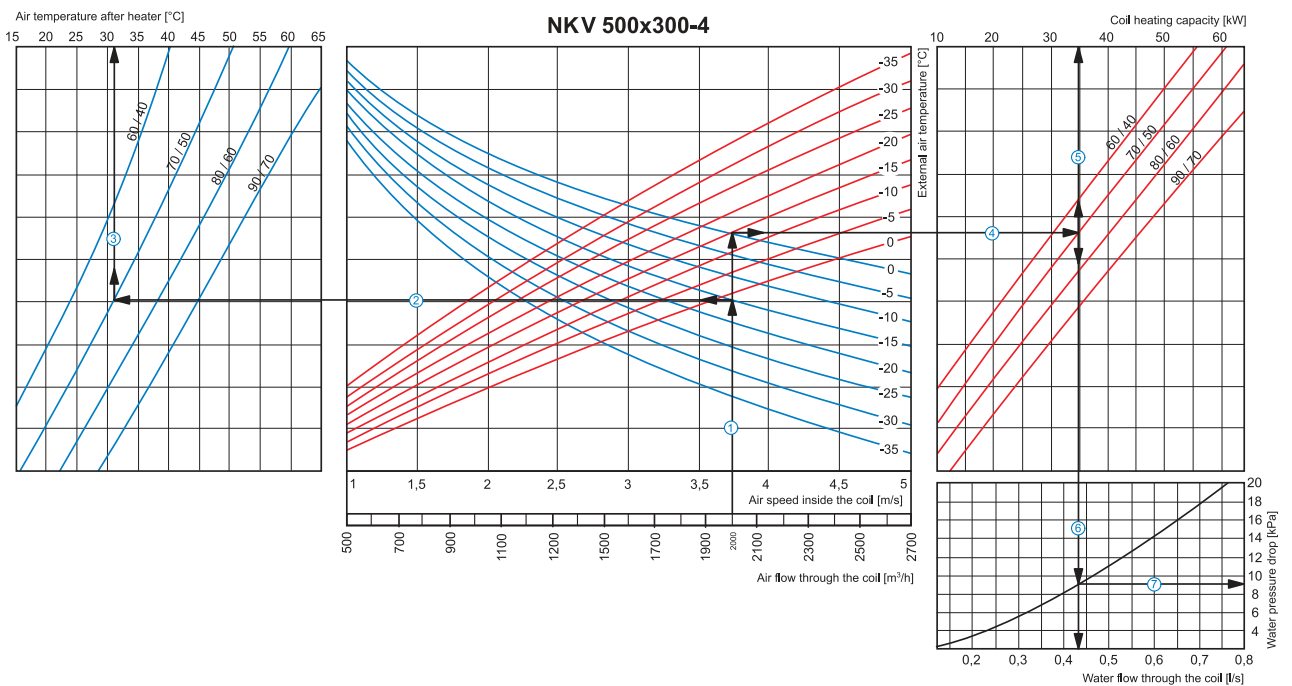

How to use water heater diagrams

Air Speed. Starting from 2000 m³/h on the air flow scale draw a vertical line ① till the air speed axis which makes about 3.75 m/s.

Supply air temperature. Prolong the line ① up to the point where it crosses the outside air temperature (blue curve), e.g. -15°C; then draw a horizontal line ② from this point to the left till crossing water in/out temperature curve (70/50 °C). From this point draw a vertical line ③ to the supply air temperature axis on top of the graphic (+31°C).

Heating coil capacity. Prolong the line ① up to the point where it crosses the outside air temperature indicated as red curve (e.g., -15°C) and draw a horizontal line ④ from this point to the right to the intersection of water in/out temperature curve (e.g., 70/50 °C). From this point draw a vertical line ⑤ up to the scale of heating coil capacity (35.0 kW).

Water flow. Prolong the line ⑤ down to water flow axis at the bottom of the graphic ⑥ (0.43 l/s).

Water pressure drop. Draw the line ⑦ from the point where line ⑥ crosses the black curve to the pressure drop axis. (9.0 kPa).

NKV

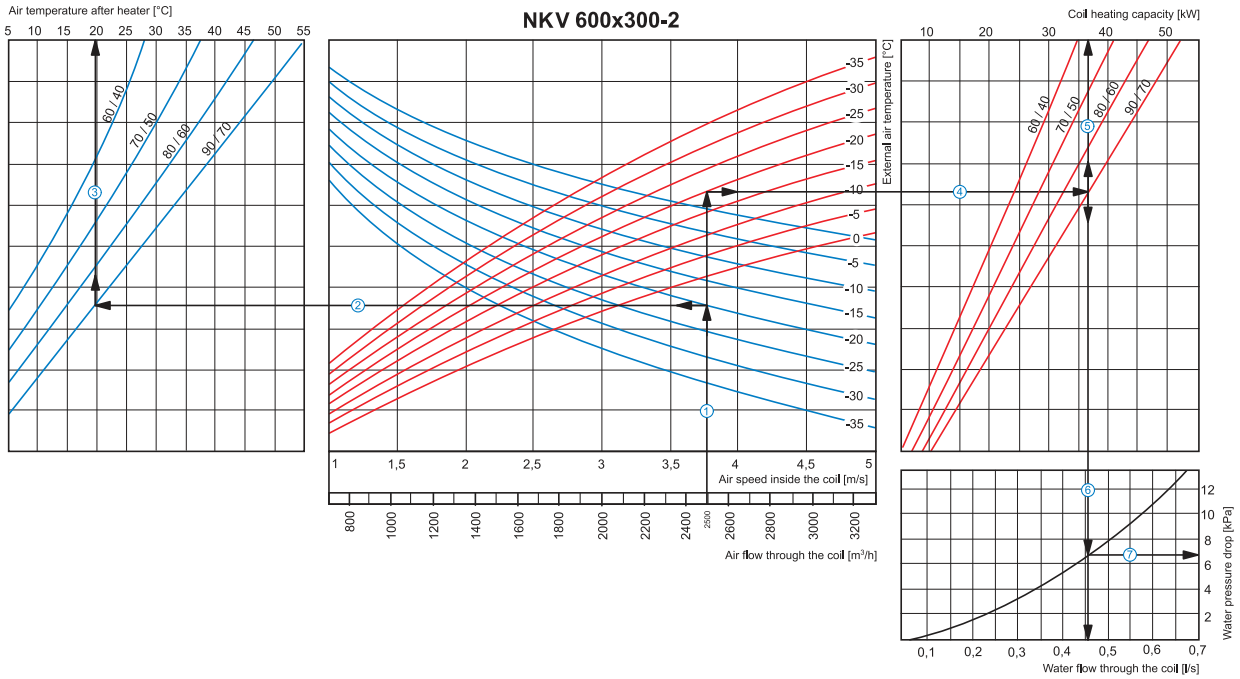

How to use water heater diagrams

Air Speed. Starting from 2500 m³/h on the air flow scale draw a vertical line ① till the air speed axis which makes about 3.75 m/s.

■ **Supply air temperature.** Prolong the line ① up to the point where it crosses the outside air temperature (blue curve), e.g. -20°C; then draw a horizontal line ② from this point to the left till crossing water in/out temperature curve (90/70 °C). From this point draw a vertical line ③ to the supply air temperature axis on top of the graphic (+20°C).

■ **Heating coil capacity.** Prolong the line ① up to the point where it crosses the outside air temperature indicated as red curve (e.g., -20°C) and draw a horizontal line ④ from this point to the right to the intersection of water in/out temperature curve (e.g., 90/70 °C). From this point draw a vertical line ⑤ up to the scale of heating coil capacity (37.0 kW).

■ **Water flow.** Prolong the line ⑤ down to water flow axis at the bottom of the graphic ⑥ (0.46 l/s).

■ **Water pressure drop.** Draw the line ⑦ from the point where line ⑥ crosses the black curve to the pressure drop axis. (6.7 kPa).

NKV

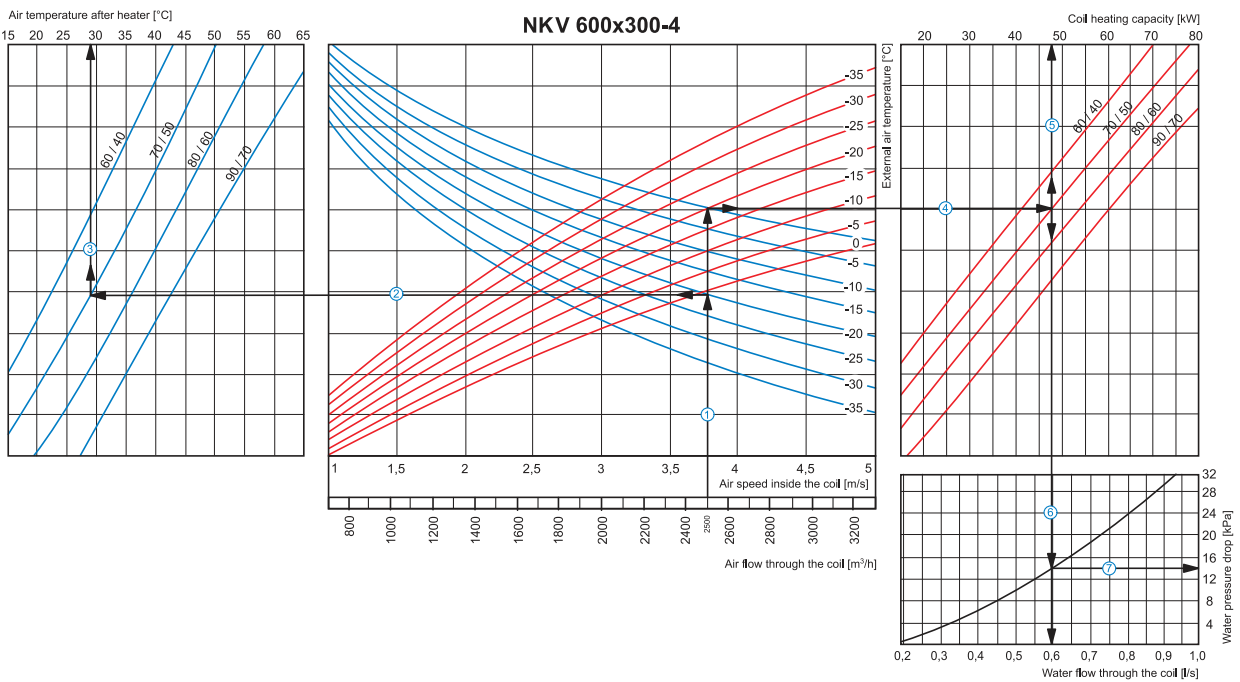

How to use water heater diagrams

Air Speed. Starting from 2500 m³/h on the air flow scale draw a vertical line ① till the air speed axis which makes about 3.75 m/s.

■ **Supply air temperature.** Prolong the line ① up to the point where it crosses the outside air temperature (blue curve), e.g. -20°C; then draw a horizontal line ② from this point to the left till crossing water in/out temperature curve (70/50 °C). From this point draw a vertical line ③ to the supply air temperature axis on top of the graphic (+29°C).

■ **Heating coil capacity.** Prolong the line ① up to the point where it crosses the outside air temperature indicated as red curve (e.g., -20°C) and draw a horizontal line ④ from this point to the right to the intersection of water in/out temperature curve (e.g., 70/50 °C). From this point draw a vertical line ⑤ up to the scale of heating coil capacity (48.0 kW).

■ **Water flow.** Prolong the line ⑤ down to water flow axis at the bottom of the graphic ⑥ (0.6 l/s).

■ **Water pressure drop.** Draw the line ⑦ from the point where line ⑥ crosses the black curve to the pressure drop axis. (14.0 kPa).

NKV

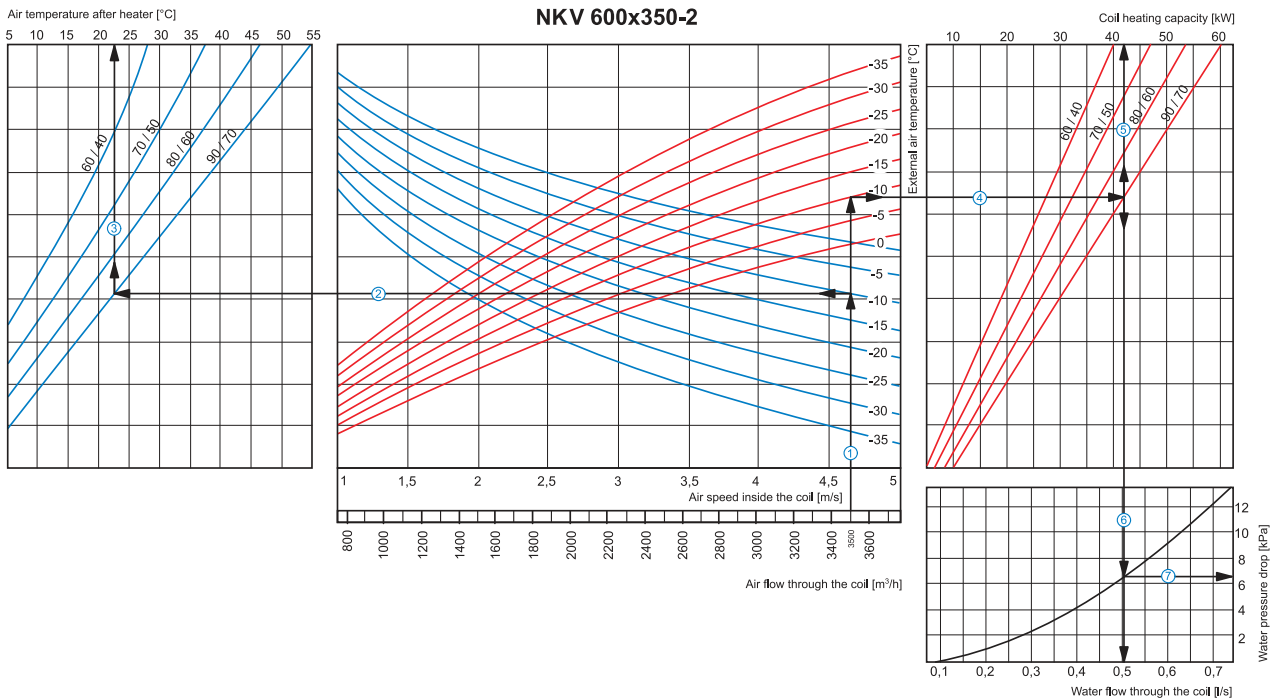

How to use water heater diagrams

Air Speed. Starting from 3500 m³/h on the air flow scale draw a vertical line ① till the air speed axis which makes about 4.65 m/s.

- Supply air temperature. Prolong the line ① up to the point where it crosses the outside air temperature (blue curve), e.g. -10°C; then draw a horizontal line ② from this point to the left till crossing water in/out temperature curve (90/70 °C). From this point draw a vertical line ③ to the supply air temperature axis on top of the graphic (+22.5°C).
- Heating coil capacity. Prolong the line ① up to the point where it crosses the outside air temperature indicated as red curve (e.g., -10°C) and draw a horizontal line ④ from this point to the right to the intersection of water in/out temperature curve (e.g., 90/70 °C). From this point draw a vertical line ⑤ up to the scale of heating coil capacity (42.0 kW).
- water flow . Prolong the line ⑤ down to water flow axis at the bottom of the graphic ⑥ (0.5 l/s).
- Water pressure drop. Draw the line ⑦ from the point where line ⑥ crosses the black curve to the pressure drop axis. (6.5 kPa).

NKV

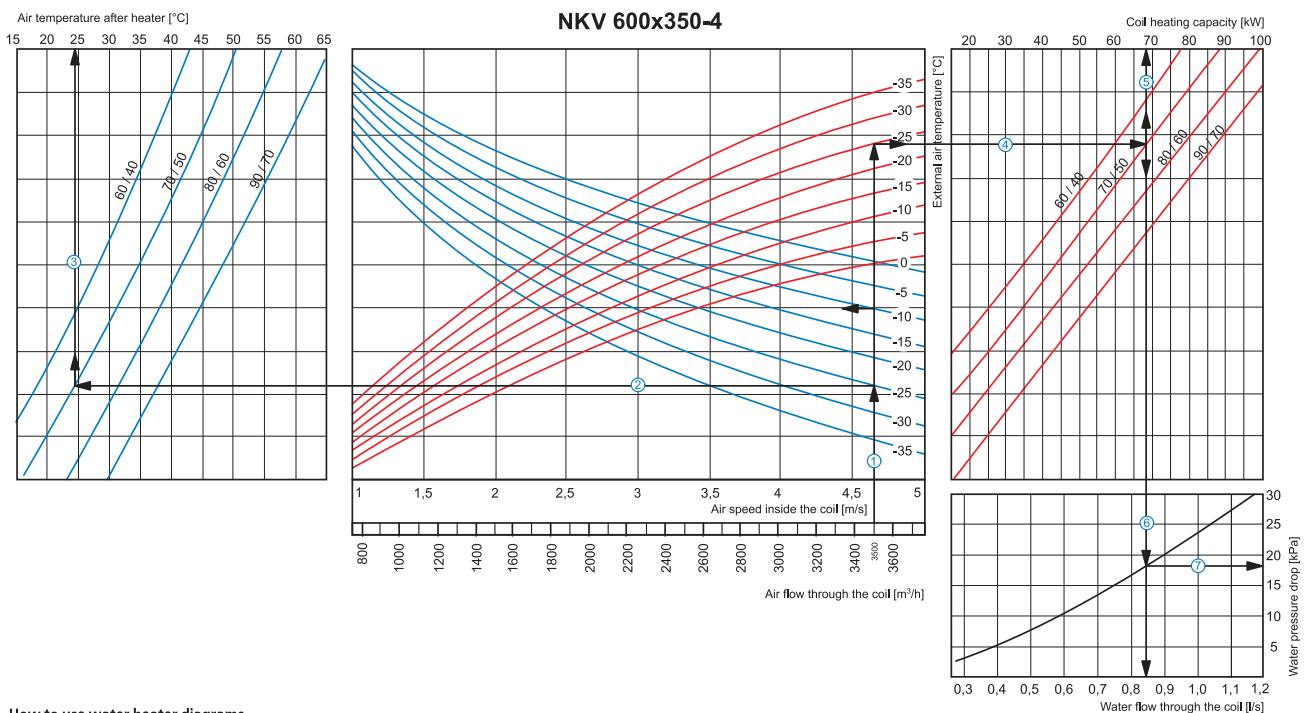

How to use water heater diagrams

Air Speed. Starting from 3500 m³/h on the air flow scale draw a vertical line ① till the air speed axis which makes about 4.65 m/s.

- Supply air temperature. Prolong the line ① up to the point where it crosses the outside air temperature (blue curve), e.g. -25°C; then draw a horizontal line ② from this point to the left till crossing water in/out temperature curve (70/50 °C). From this point draw a vertical line ③ to the supply air temperature axis on top of the graphic (+24°C).
- Heating coil capacity. Prolong the line ① up to the point where it crosses the outside air temperature indicated as red curve (e.g., -25°C) and draw a horizontal line ④ from this point to the right to the intersection of water in/out temperature curve (e.g., 70/50 °C). From this point draw a vertical line ⑤ up to the scale of heating coil capacity (68.0 kW).
- water flow . Prolong the line ⑤ down to water flow axis at the bottom of the graphic ⑥ (0.84 l/s).
- Water pressure drop. Draw the line ⑦ from the point where line ⑥ crosses the black curve to the pressure drop axis. (18.0 kPa).

NKV

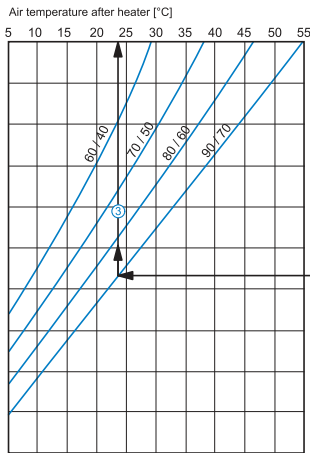

NKV 700x400-2

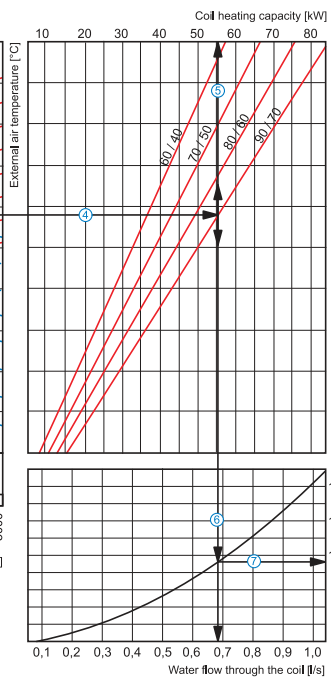
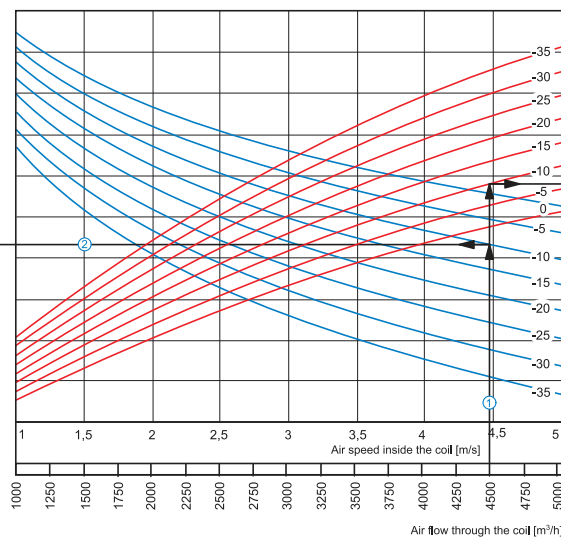

How to use water heater diagrams

Air Speed. Starting from 4500 m³/h on the air flow scale draw a vertical line ① till the air speed axis which makes about 4.45 m/s.

■ **Supply air temperature.** Prolong the line ① up to the point where it crosses the outside air temperature (blue curve), e.g. -10°C; then draw a horizontal line ② from this point to the left till crossing water in/out temperature curve (90/70 °C). From this point draw a vertical line ③ to the supply air temperature axis on top of the graphic (+24°C).

■ **Heating coil capacity.** Prolong the line ① up to the point where it crosses the outside air temperature indicated as red curve (e.g., -10°C) and draw a horizontal line ④ from this point to the right to the intersection of water in/out temperature curve (e.g., 90/70 °C). From this point draw a vertical line ⑤ up to the scale of heating coil capacity (55.0 kW).

■ **Water flow.** Prolong the line ⑤ down to water flow axis at the bottom of the graphic ⑥ (0.68 l/s).

■ **Water pressure drop.** Draw the line ⑦ from the point where line ⑥ crosses the black curve to the pressure drop axis. (9.2 kPa).

NKV

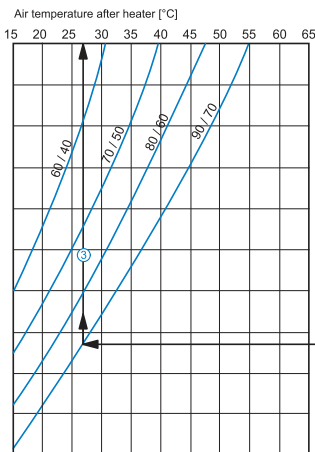

NKV 700x400-3

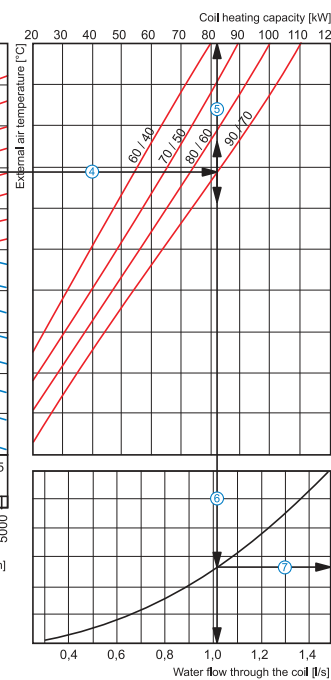
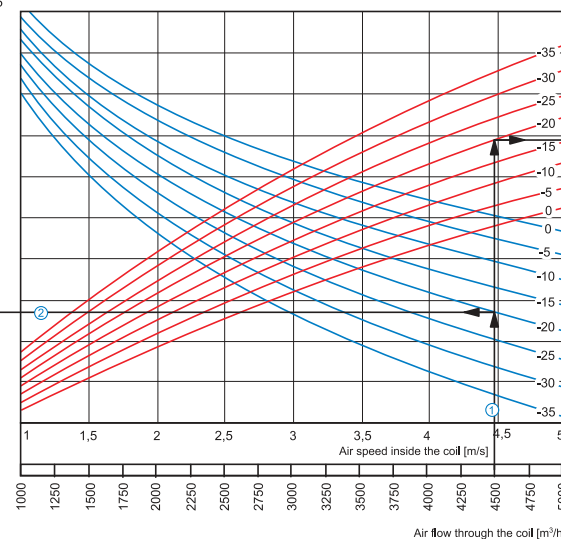

How to use water heater diagrams

Air Speed. Starting from 4500 m³/h on the air flow scale draw a vertical line ① till the air speed axis which makes about 4.45 m/s.

■ **Supply air temperature.** Prolong the line ① up to the point where it crosses the outside air temperature (blue curve), e.g. -20°C; then draw a horizontal line ② from this point to the left till crossing water in/out temperature curve (90/70 °C). From this point draw a vertical line ③ to the supply air temperature axis on top of the graphic (+27°C).

■ **Heating coil capacity.** Prolong the line ① up to the point where it crosses the outside air temperature indicated as red curve (e.g., -20°C) and draw a horizontal line ④ from this point to the right to the intersection of water in/out temperature curve (e.g., 90/70 °C). From this point draw a vertical line ⑤ up to the scale of heating coil capacity (82.0 kW).

■ **Water flow.** Prolong the line ⑤ down to water flow axis at the bottom of the graphic ⑥ (1.02 l/s).

■ **Water pressure drop.** Draw the line ⑦ from the point where line ⑥ crosses the black curve to the pressure drop axis. (13.0 kPa).

NKV

NKV 800x500-2

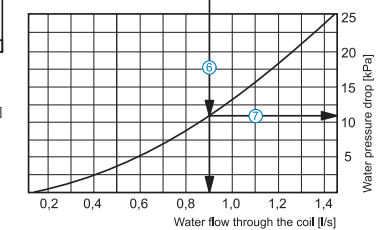
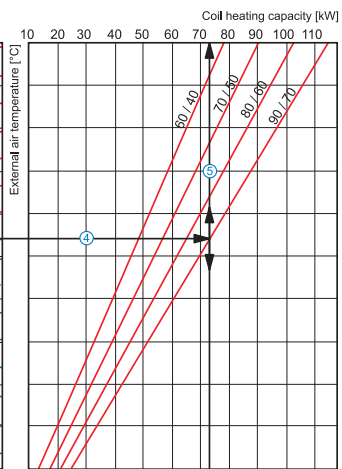
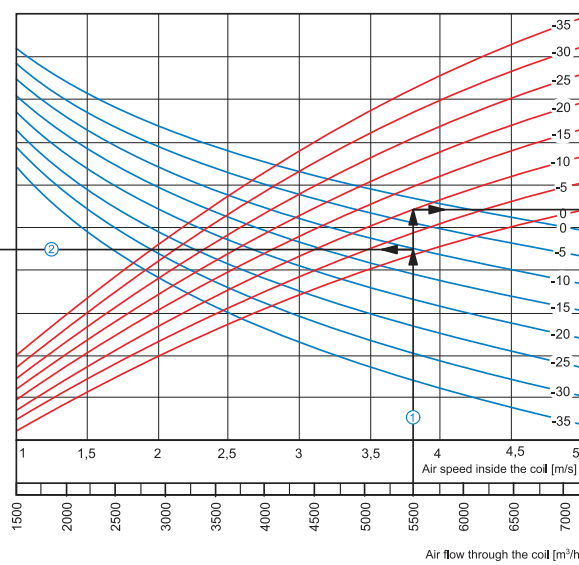
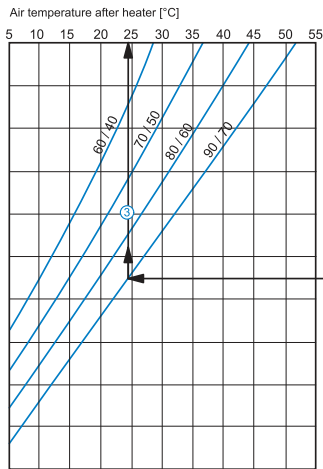

How to use water heater diagrams

Air Speed. Starting from 5500 m³/h on the air flow scale draw a vertical line ① till the air speed axis. It makes 3.8 m/s.

- Supply air temperature. Prolong the line ① up to the point where it crosses the outside air temperature (blue curve), e.g. -10°C; then draw a horizontal line ② from this point to the left till crossing water in/out temperature curve (90/70 °C). From this point draw a vertical line ③ to the supply air temperature axis on top of the graphic (+24.5°C).
- Heating coil capacity. Prolong the line ① up to the point where it crosses the outside air temperature indicated as red curve (e.g., -10°C) and draw a horizontal line ④ from this point to the right to the intersection of water in/out temperature curve (e.g., 90/70 °C). From this point draw a vertical line ⑤ up to the scale of heating coil capacity (73.0 kW).
- Water flow. Prolong the line ⑤ down to water flow axis at the bottom of the graphic ⑥ (0.9 l/s).
- Water pressure drop. Draw the line ⑦ from the point where line ⑥ crosses the black curve to the pressure drop axis. (11.0 kPa).

NKV

NKV 800x500-3

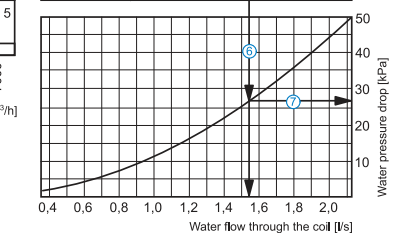
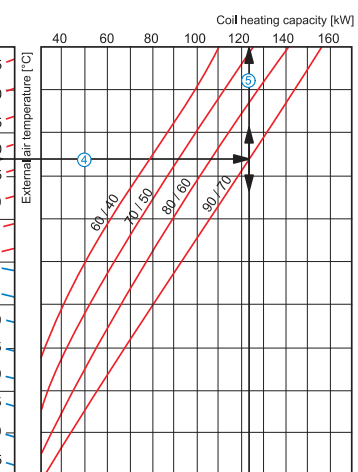
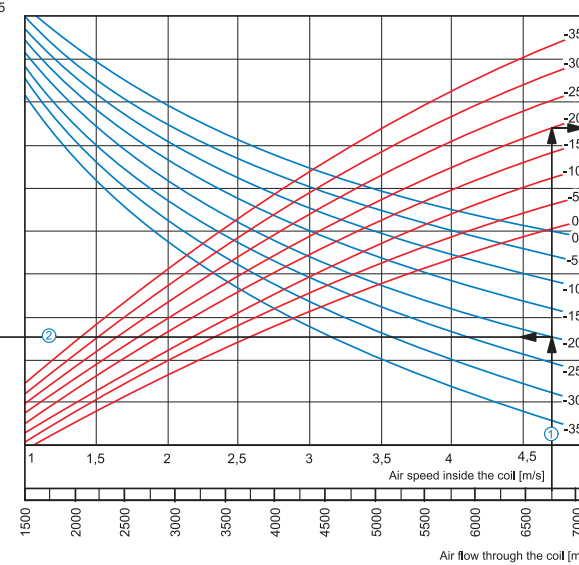
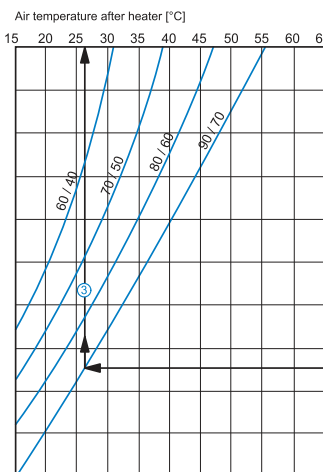

How to use water heater diagrams

Air Speed. Starting from 6750 m³/h on the air flow scale draw a vertical line ① till the air speed axis. It makes 4.7 m/s.

- Supply air temperature. Prolong the line ① up to the point where it crosses the outside air temperature (blue curve), e.g. -20°C; then draw a horizontal line ② from this point to the left till crossing water in/out temperature curve (90/70 °C). From this point draw a vertical line ③ to the supply air temperature axis on top of the graphic (+26°C).
- Heating coil capacity. Prolong the line ① up to the point where it crosses the outside air temperature indicated as red curve (e.g., -20°C) and draw a horizontal line ④ from this point to the right to the intersection of water in/out temperature curve (e.g., 90/70 °C). From this point draw a vertical line ⑤ up to the scale of heating coil capacity (123.0 kW).
- Water flow. Prolong the line ⑤ down to water flow axis at the bottom of the graphic ⑥ (1.54 l/s).
- Water pressure drop. Draw the line ⑦ from the point where line ⑥ crosses the black curve to the pressure drop axis. (27.0 kPa).

NKV

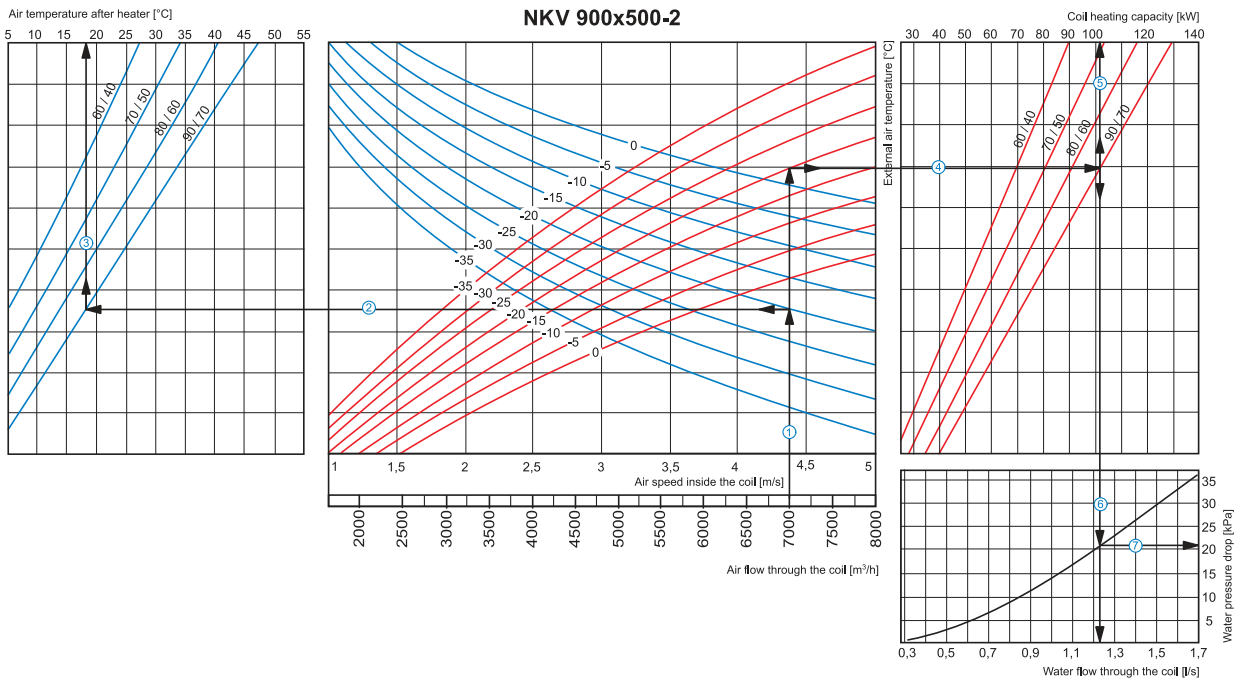

How to use water heating coils diagrams

Air Speed. Starting from 7000 m³/h on the air flow scale draw a vertical line ① till the air speed axis. It makes 4.4 m/s.

- **Supply air temperature.** Prolong the line ① up to the point where it crosses the outside air temperature (blue curve), e.g. -20°C, then draw a horizontal line ② from this point to the left till crossing water in/out temperature curve (90/70 °C). From this point draw a vertical line ③ to the supply air temperature axis on top of the graphic (+18°C).
- **Heating coil capacity.** Prolong the line ① up to the point where it crosses the outside air temperature indicated as red curve (e.g., -20°C) and draw a horizontal line ④ from this point to the right to the intersection of water in/out temperature curve (e.g., 90/70 °C). From this point draw a vertical line ⑤ up to the scale of heating coil capacity (102.0 kW).
- **Water flow.** Prolong the line ⑤ down to water flow axis at the bottom of the graphic ⑥ (1.23 l/s).
- **Water pressure drop.** Draw the line ⑦ from the point where line ⑥ crosses the black curve to the pressure drop axis. (21.0 kPa).

NKV

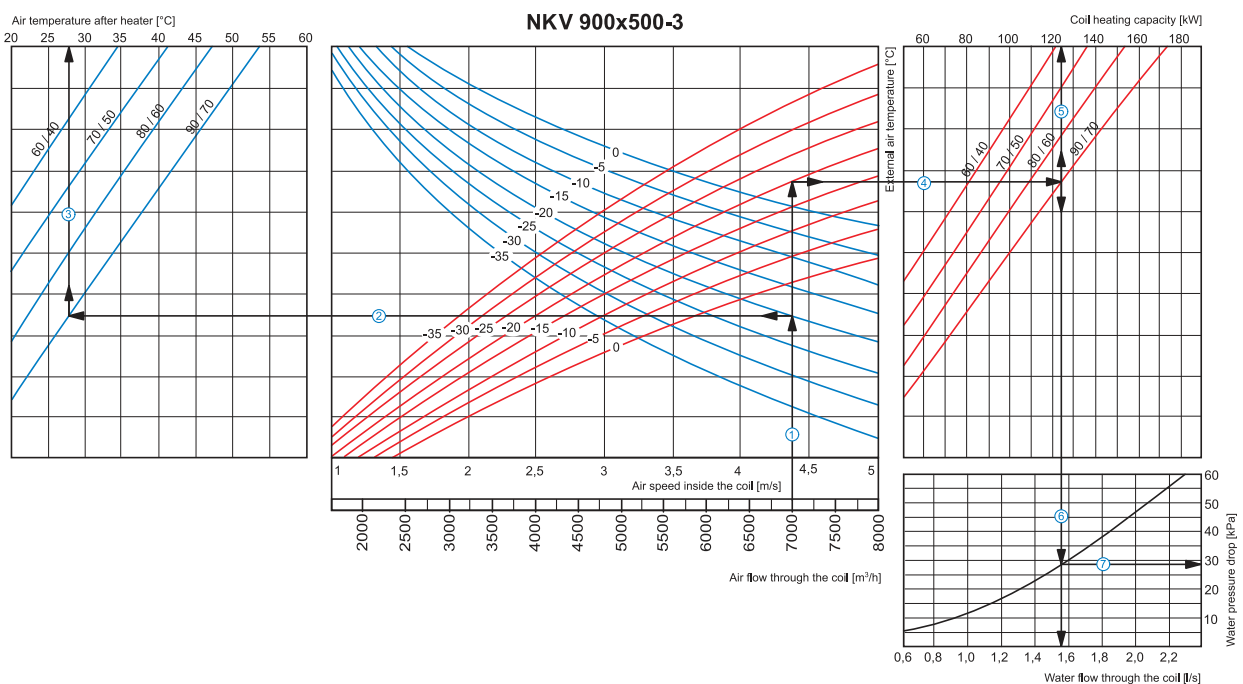

How to use water heater diagrams

Air Speed. Starting from 7000 m³/h on the air flow scale draw a vertical line ① till the air speed axis. It makes 4.4 m/s.

- **Supply air temperature.** Prolong the line ① up to the point where it crosses the outside air temperature (blue curve), e.g. -20°C, then draw a horizontal line ② from this point to the left till crossing water in/out temperature curve (90/70 °C). From this point draw a vertical line ③ to the supply air temperature axis on top of the graphic (+28°C).
- **Heating coil capacity.** Prolong the line ① up to the point where it crosses the outside air temperature indicated as red curve (e.g., -20°C) and draw a horizontal line ④ from this point to the right to the intersection of water in/out temperature curve (e.g., 90/70 °C). From this point draw a vertical line ⑤ up to the scale of heating coil capacity (124.0 kW).
- **Water flow.** Prolong the line ⑤ down to water flow axis at the bottom of the graphic ⑥ (1.55 l/s).
- **Water pressure drop.** Draw the line ⑦ from the point where line ⑥ crosses the black curve to the pressure drop axis. (28.0 kPa).

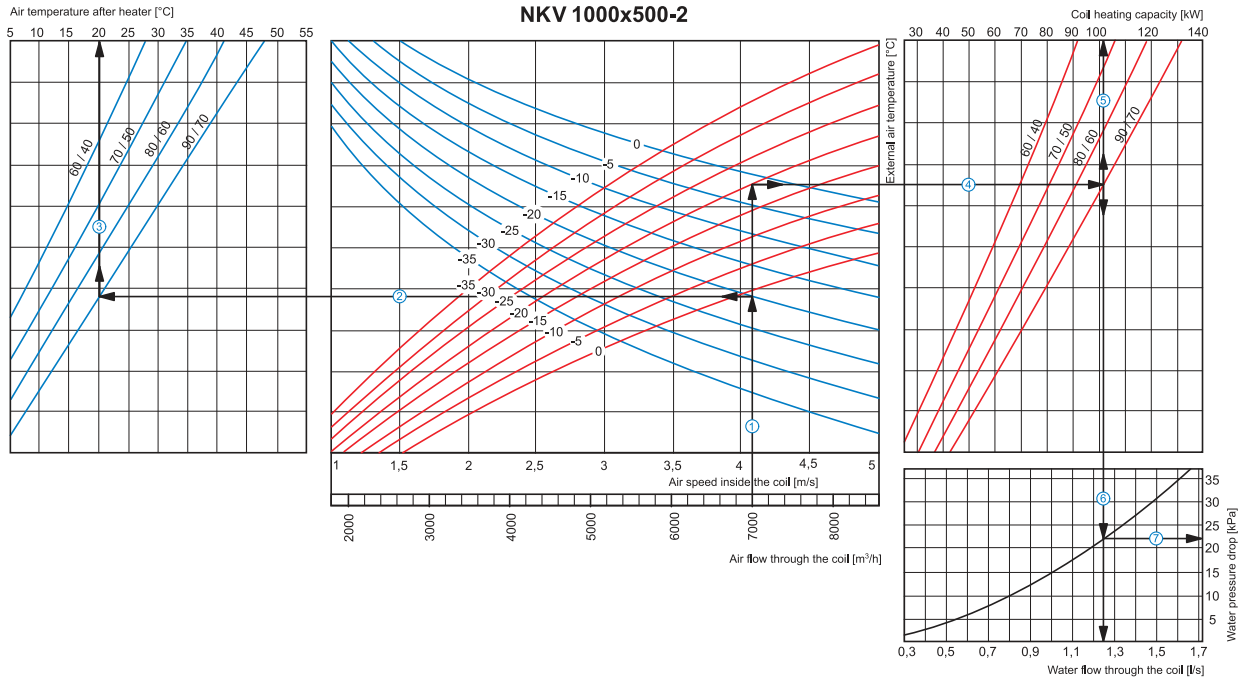

How to use water heater diagrams

Air Speed. Starting from 7000 m³/h on the air flow scale draw a vertical line ① till the air speed axis. It makes 4.1 m/s.

■ **Supply air temperature.** Prolong the line ① up to the point where it crosses the outside air temperature (blue curve), e.g. -20°C; then draw a horizontal line ② from this point to the left till crossing water in/out temperature curve (90/70 °C). From this point draw a vertical line ③ to the supply air temperature axis on top of the graphic (+20°C).

■ **Heating coil capacity.** Prolong the line ① up to the point where it crosses the outside air temperature indicated as red curve (e.g., -20°C) and draw a horizontal line ④ from this point to the right to the intersection of water in/out temperature curve (e.g., 90/70 °C). From this point draw a vertical line ⑤ up to the scale of heating coil capacity (101.0 kW).

■ **Water flow.** Prolong the line ⑤ down to water flow axis at the bottom of the graphic ⑥ (1.25 l/s).

■ **Water pressure drop.** Draw the line ⑦ from the point where line ⑥ crosses the black curve to the pressure drop axis. (22.0 kPa).

NKV

NKV 1000x500-3

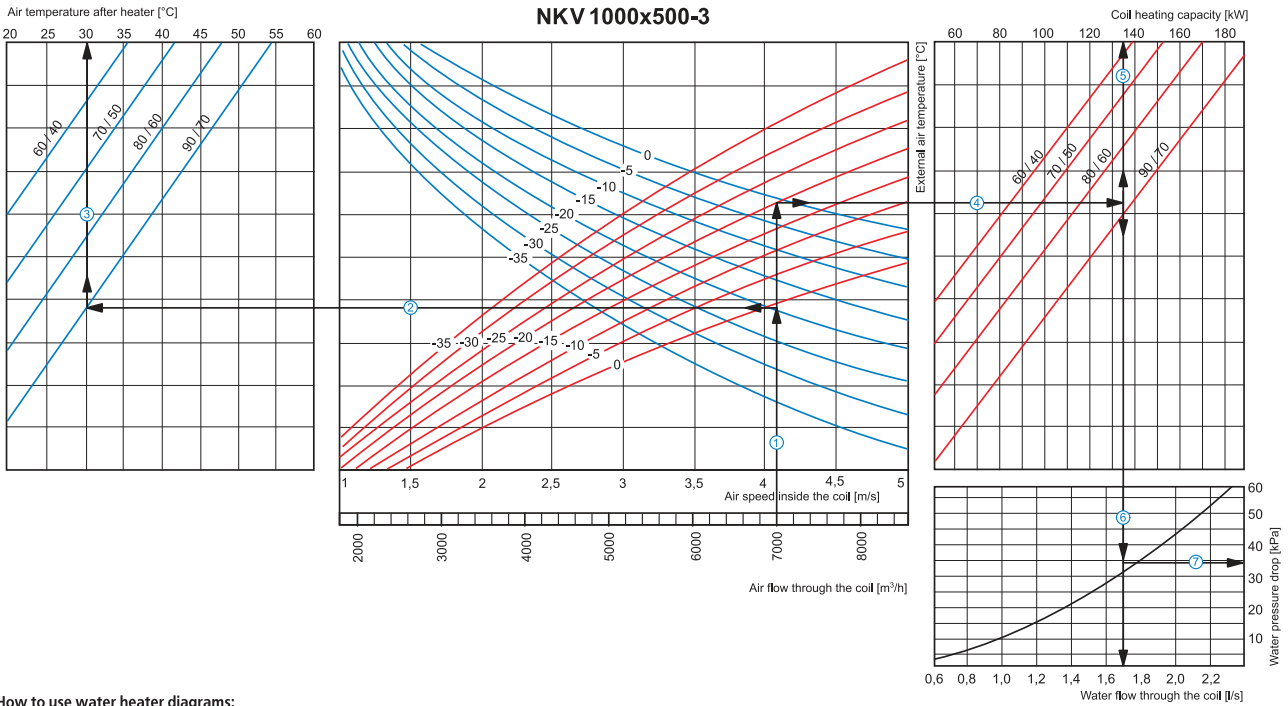

How to use water heater diagrams:

Air Speed. Starting from 7000 m³/h on the air flow scale draw a vertical line ① till the air speed axis. It makes 4.1 m/s.

- Supply air temperature. Prolong the line ① up to the point where it crosses the outside air temperature (blue curve), e.g. -20°C; then draw a horizontal line ② from this point to the left till crossing water in/out temperature curve (90/70 °C). From this point draw a vertical line ③ to the supply air temperature axis on top of the graphic (+30°C).
- Heating coil capacity. Prolong the line ① up to the point where it crosses the outside air temperature indicated as red curve (e.g., -20°C) and draw a horizontal line ④ from this point to the right to the intersection of water in/out temperature curve (e.g., 90/70 °C). From this point draw a vertical line ⑤ up to the scale of heating coil capacity (135.0 kW).
- Water flow. Prolong the line ⑤ down to water flow axis at the bottom of the graphic ⑥ (1.7 l/s).
- Water pressure drop. Draw the line ⑦ from the point where line ⑥ crosses the black curve to the pressure drop axis. (34.0 kPa).