

Series
VENTS MPA E



LCD control panel

Supply units with the air capacity up to **3500 m³/h** in the compact sound- and heat-insulated casing with electric heater

Series
VENTS MPA W



SAS908 control panel

Supply units with the air capacity up to **6500 m³/h** in the compact sound- and heat-insulated casing with water heater

■ **Description**

Air supply MPA unit is a complete ventilation unit for air filtration, air heating and supply to premises. Compatible with 400x200, 500x250, 500x300, 600x300, 600x350 and 800x500 mm rectangular air ducts.

■ **Casing**

The casing is made of aluzink with internal 25 mm heat- and sound-insulating layer made of mineral wool.

■ **Filter**

G4 incorporated filter ensures high degree of supply air purification.

■ **Heater**

Both electric heater (MPA E models) and water/glycol heating coils (MPA W models) are used for heating

of supply air during winter and off-season period. Tubular heating elements of the electric fan heater are ribbed to increase the heat exchange surface area and heat transfer to supply air.

■ **Fan**

Centrifugal double-inlet fan with forward-curved blades and built-in overheating protection with automatic restart. The fan motor and impeller are dynamically balanced in two planes. The ball bearings in the electric motor are maintenance free and designed for at least 40000 hours operation.

■ **Control and automation**

Two options for supply unit modifications are possible:

1. No control. Customer-defined and customer-selected automation system.

2. Built-in control and automation system provides the fan air capacity control by means of three speed switching, supply air temperature setting, filter clogging degree control.

Additionally the automation system provides thermal overheating protection for the tubular heating elements. The remote control of the unit is effected by means of external control unit with 10 meters wire supplied as a standard.

Supply units MPA 3200 W, MPA 3500 W, MPA 5000 W have no control panel.

■ **MPA E control and protection functions**

- ▶ remote switching the unit on and off;
- ▶ setting and maintaining the desired temperature of supply air with the control panel;
- ▶ motor speed controlling and regulating the air capacity accordingly by means of the control panel;

Designation key: _____

Series	Rated air flow, m ³ /h	Heater type	Phase
VENTS MPA	800, 1200, 1800, 2500, 3200, 3500, 5000	E - electrical heating elements; W - water coils;	1 – single-phase; 3 – three-phase

Accessories

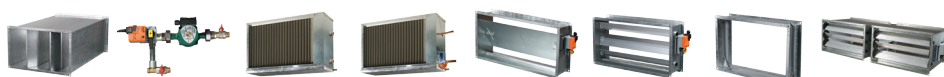

page 248 page 282 page 284 page 290 page 299 page 300 page 303 page 304

Offered options to the units

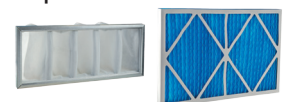

page 168 page 168

- ▶ working-out of the required patterns during the unit switching on and off;
- ▶ unit timer-dependent operation;
- ▶ active electric heating elements overheating protection;
- ▶ disabling electric air heater operation when the motor is not running;
- ▶ two electric heater over-heating thermostats;
- ▶ filter clogging control through the differential pressure sensor.

■ MPA W control and protection functions

- ▶ switching the unit on and off;
- ▶ switching to one of three available motor speed;
- ▶ keeping the set temperature of supply air by means of controlling the three-way valve actuator that regulates the heat medium supply to the heater;
- ▶ water (glycol) heating coils freezing protection

as the leaving air temperature and leaving heat medium temperature sensors require;

- ▶ controlling the of external circulation pump operation installed on the heat medium entering into the water (glycol) coils;
- ▶ controlling the condensing unit of the air cooler with respect to the indoor temperature in case of additional air cooler in the duct;
- ▶ controlling supply fan operation;
- ▶ air filter clogging control;
- ▶ controlling the external air damper actuator;
- ▶ emergency stop on fire alarm signal.

Due to the mixing unit the control panel can keep the set indoor temperature by means of regulating the heat medium flow through the water (glycol) coils. The use of the mixing unit with the pump provides the referred above regulation with the pressure difference of the heat medium in the main

and return line below 40 kPa. The mixing unit with the pump serves for freezing protection of the heat exchanger and its operation algorithm provides some time span for the users to take required measures in case of emergency.

■ Mounting

The supply unit can be mounted on the floor, suspended to the ceiling by means of a seat angle with a flexible connector or fixed to the wall using brackets. The unit can be installed either in such service spaces as balcony, storeroom, basement, roof space or in main premises above the suspended ceiling, in the pocket or placed directly in the room. The unit can be mounted in any position but the vertical one with air downstream because the heating elements are not allowed under the fan. Access for the unit maintenance and filter cleaning shall be provided.

Unit overall dimensions:

Type	Dimensions, [mm]									
	B	B1	B2	B3	H	H1	H2	L	L1	L2
MPA 800 E1	400	420	549	500	200	220	352	650	530	-
MPA 1200 E3	400	420	549	500	200	220	352	650	530	-
MPA 1800 E3	500	520	649	600	250	270	480	800	680	-
MPA 2500 E3	500	520	649	600	300	320	480	800	680	-
MPA 3200 E3	600	620	759	710	300	320	530	1000	880	440
MPA 3500 E3	600	620	759	710	350	370	530	1000	880	440

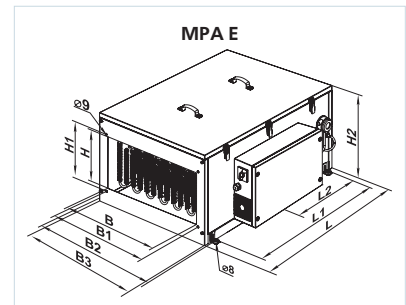

Unit overall dimensions:

Type	Dimensions, [mm]									
	B	B1	B2	B3	H	H1	H2	L	L1	L2
MPA 800 W	400	420	549	500	200	220	352	650	530	-
MPA 1200 W	400	420	549	500	200	220	352	650	530	-
MPA 1800 W	500	520	649	600	250	270	480	800	680	-
MPA 2500 W	500	520	649	600	300	320	480	800	680	-
MPA 3200 W	600	620	759	710	300	320	530	1000	880	440
MPA 3500 W	600	620	759	710	350	370	530	1000	880	440
MPA 5000 W	800	820	971	925	500	520	670	1299	720	360

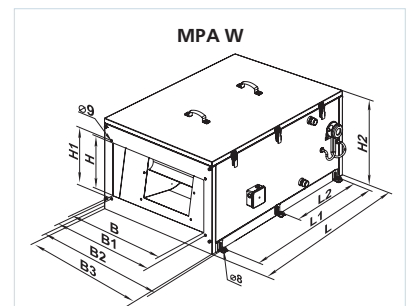

VENTS
MPA E /
MPA W
SUPPLY UNIT SERIES

SUPPLY UNITS

Technical data:

	MPA 800 E1	MPA 800 W	MPA 1200 E3	MPA 1200 W
Unit supply voltage [V / 50 Hz]	1~ 230		3~ 400	1~ 230
Maximum fan power [W]	245		410	
Fan current [A]	1,08		1,8	
Electric heater capacity [kW]	3,3	-	9,9	-
Electric heater current [A]	14,3	-	14,3	-
Number of water (glycol) coil rows	-	4	-	4
Total power of the unit [kW]	3,55	0,245	9,94	0,410
Total current of the unit [A]	15,38	1,08	16,1	1,8
Air capacity [m ³ /h]	800	750	1200	1200
RPM	1650		1850	
Noise level at 3m [dB(A)]	35		38	
Operating temperature [°C]	-25 up to +45	-40 up to +45	-25 up to +45	-40 up to +45
Casing material	aluzink		aluzink	
Insulation	25 mm mineral wool		25 mm mineral wool	
Filter	G4		G4	
Connected air duct size [mm]	400x200		400x200	
Weight, [kg]	36,2	41,3	38,9	42,8

* no control box (with the control box for MPA...E +130 mm)

Technical data:

	MPA 1800 E3	MPA 1800 W	MPA 2500 E3	MPA 2500 W
Unit supply voltage [V / 50 Hz]	3~ 400	1~ 230	3~ 400	1~ 230
Maximum fan power [W]	490		650	
Fan current [A]	2,15		2,84	
Electric heater capacity [kW]	18,0	-	18,0	-
Electric heater current [A]	26,0	-	26,0	-
Number of water (glycol) coil rows	-	4	-	4
Total power of the unit [kW]	18,49	0,490	18,65	0,650
Total current of the unit [A]	28,15	2,15	28,84	2,84
Air capacity [m ³ /h]	2000	1870	2500	2150
RPM	1100		1000	
Noise level at 3m [dB(A)]	40		45	
Operating temperature [°C]	-25 up to +45	-40 up to +45	-25 up to +45	-40 up to +45
Casing material	aluzink		aluzink	
Insulation	25 mm mineral wool		25 mm mineral wool	
Filter	G4		G4	
Connected air duct size [mm]	500x250		500x300	
Weight, [kg]	61,5	62,5	62	63

* no control box (with the control box for MPA...E +130 mm)

Technical data:

	MPA 3200 E3	MPA 3200 W	MPA 3500 E3	MPA 3500 W	MPA 5000 W
Unit supply voltage [V / 50 Hz]	3~ 400Y		3~ 400Y		3~ 400
Maximum fan power [W]	1270		1270		1800
Fan current [A]	2,3		2,3		4,5
Electric heater capacity [kW]	25,2	-	25,2	-	-
Electric heater current [A]	36,4	-	36,4	-	-
Number of water (glycol) coil rows	-	4	-	4	4
Total power of the unit [kW]	26,47	1,270	26,47	1,270	1,80
Total current of the unit [A]	38,7	2,3	38,7	2,3	4,5
Air capacity [m³/h]	3200	3000	3500	3250	6500
RPM	1200		1200		1400
Noise level at 3m [dB(A)]	53		53		55
Operating temperature [°C]	-40 up to +45		-40 up to +45		-40 up to +45
Casing material	aluzink		aluzink		aluzink
Insulation	25 mm mineral wool		25 mm mineral wool		
Filter	G4		G4		G4
Connected air duct size [mm]	600x300		600x350		800x500
Weight, [kg]	69,4	73,2	69,3	73,1	136

* no control box (with the control box for MPA...E +130 mm)

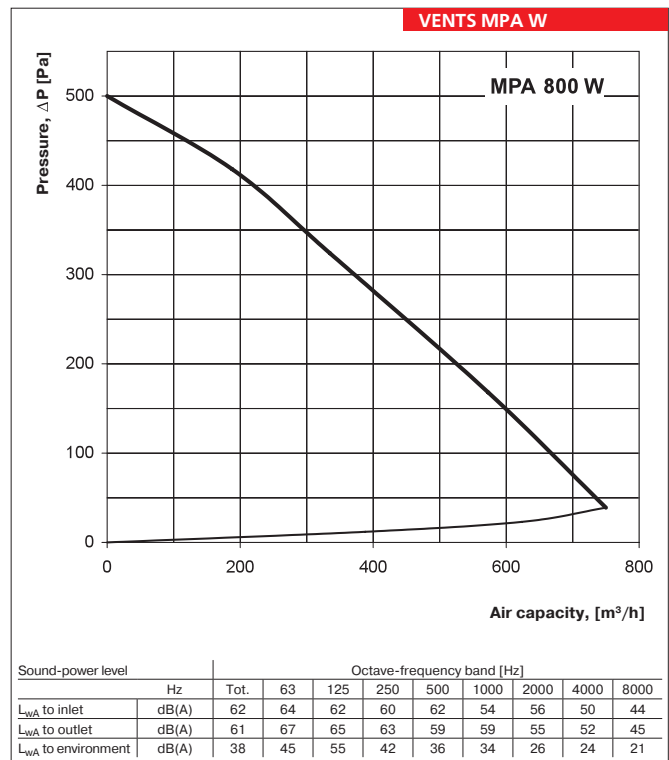
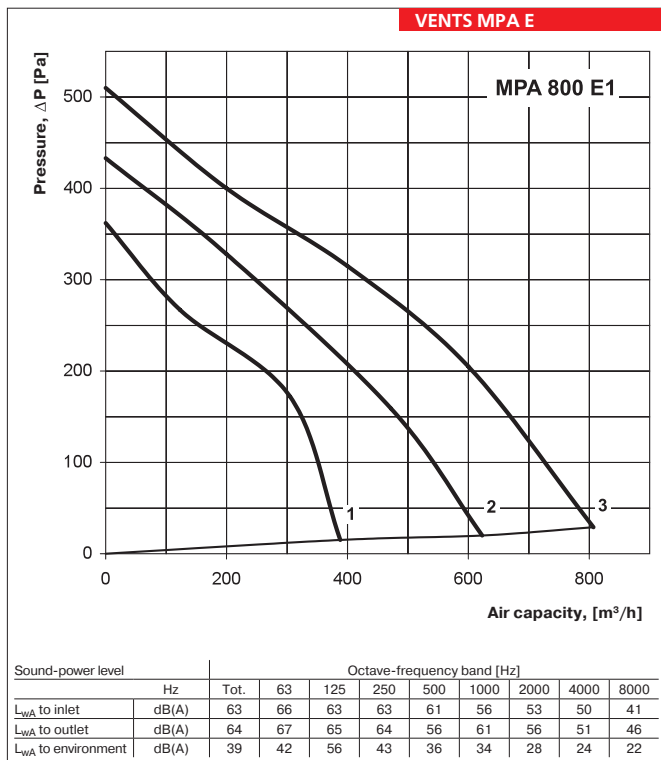

VENTS
 MPA E /
 MPA W
 SUPPLY UNIT SERIES

VENTS MPA E

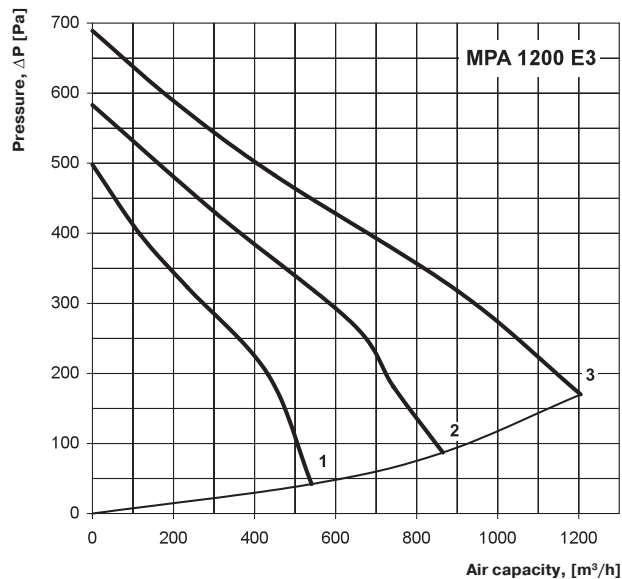

Sound-power level	Hz	Octave-frequency band [Hz]								
		Tot.	63	125	250	500	1000	2000	4000	8000
L_{WA} to inlet	dB(A)	67	66	66	68	66	60	63	60	55
L_{WA} to outlet	dB(A)	72	71	70	68	68	65	60	60	57
L_{WA} to environment	dB(A)	45	55	54	48	52	40	37	34	35

VENTS MPA W

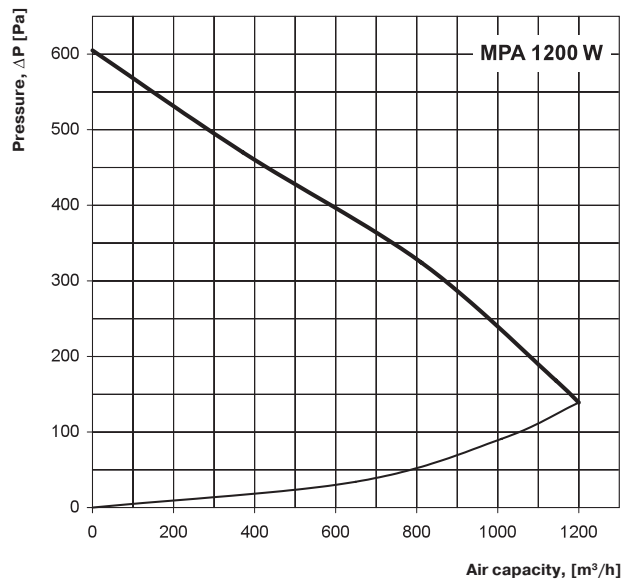

Sound-power level	Hz	Octave-frequency band [Hz]								
		Tot.	63	125	250	500	1000	2000	4000	8000
L_{WA} to inlet	dB(A)	71	70	68	66	68	62	61	61	56
L_{WA} to outlet	dB(A)	71	68	69	67	64	67	62	61	57
L_{WA} to environment	dB(A)	48	56	54	48	53	40	39	35	33

VENTS MPA E

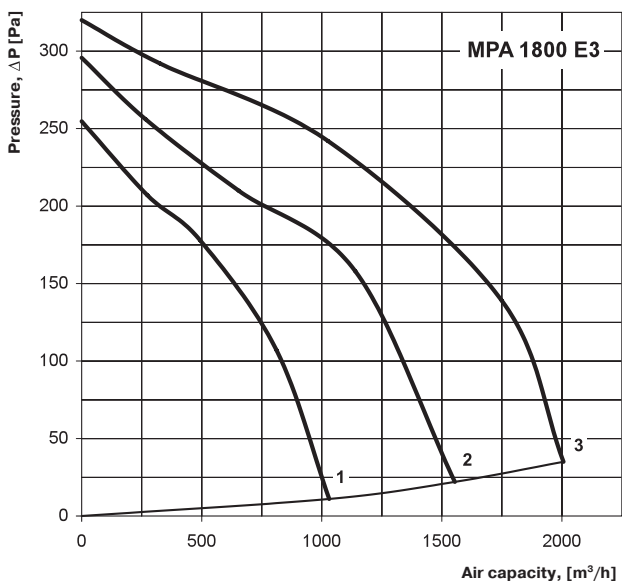

Sound-power level	Hz	Octave-frequency band [Hz]								
		Tot.	63	125	250	500	1000	2000	4000	8000
L_{WA} to inlet	dB(A)	74	79	76	74	67	67	64	64	54
L_{WA} to outlet	dB(A)	75	82	78	74	68	73	66	70	67
L_{WA} to environment	dB(A)	52	64	62	54	48	44	40	36	34

VENTS MPA W

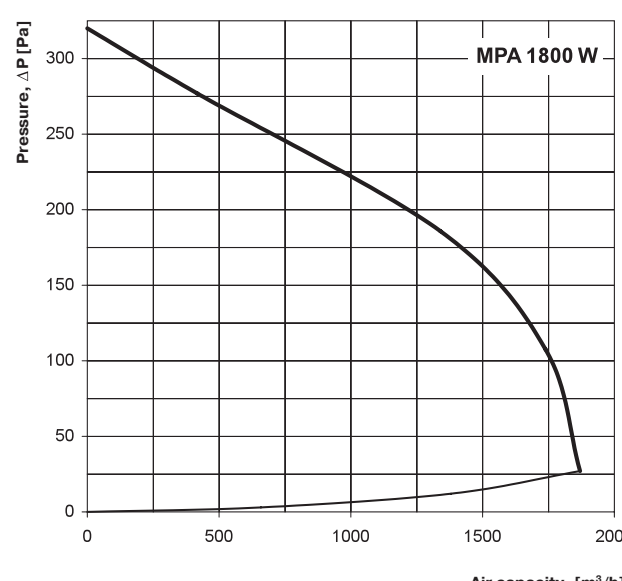

Sound-power level	Hz	Octave-frequency band [Hz]								
		Tot.	63	125	250	500	1000	2000	4000	8000
L_{WA} to inlet	dB(A)	73	78	77	77	67	68	62	63	57
L_{WA} to outlet	dB(A)	75	79	78	74	68	73	66	69	66
L_{WA} to environment	dB(A)	51	63	61	54	47	44	40	37	33

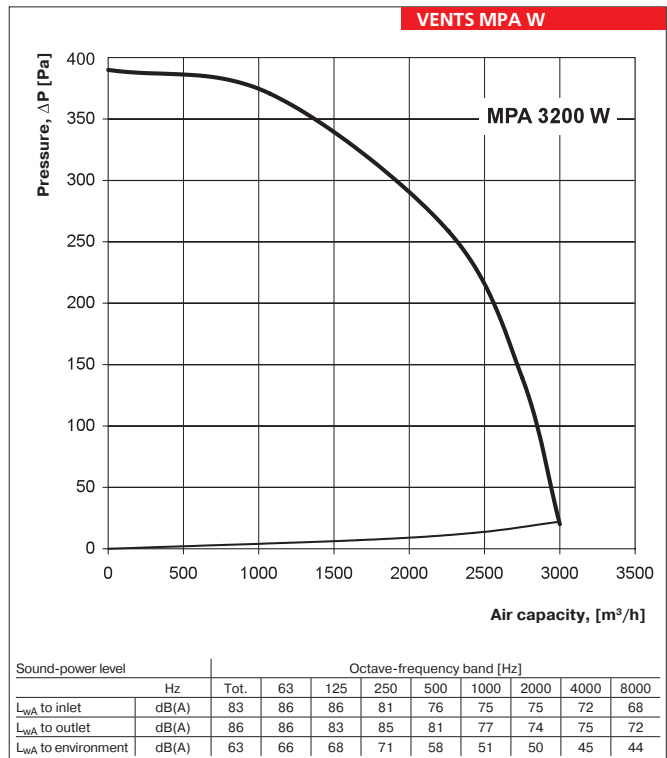
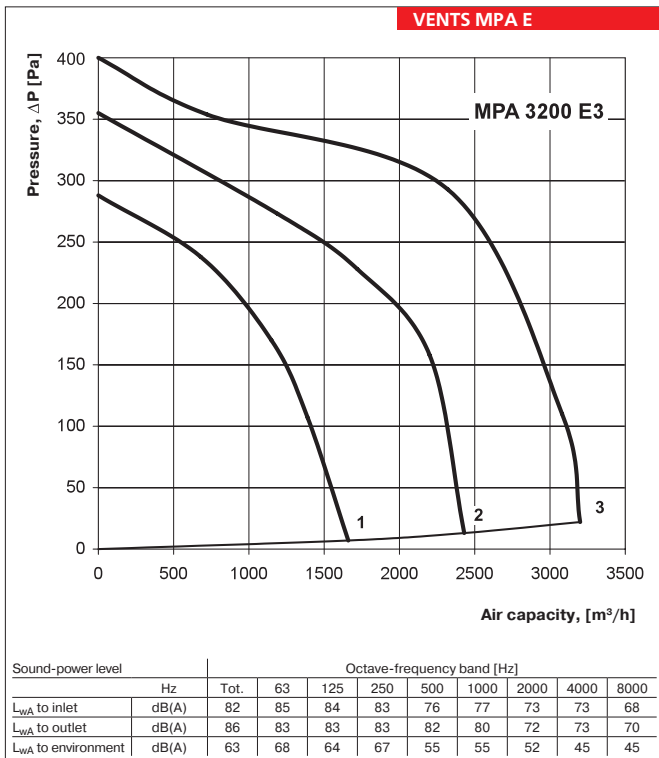
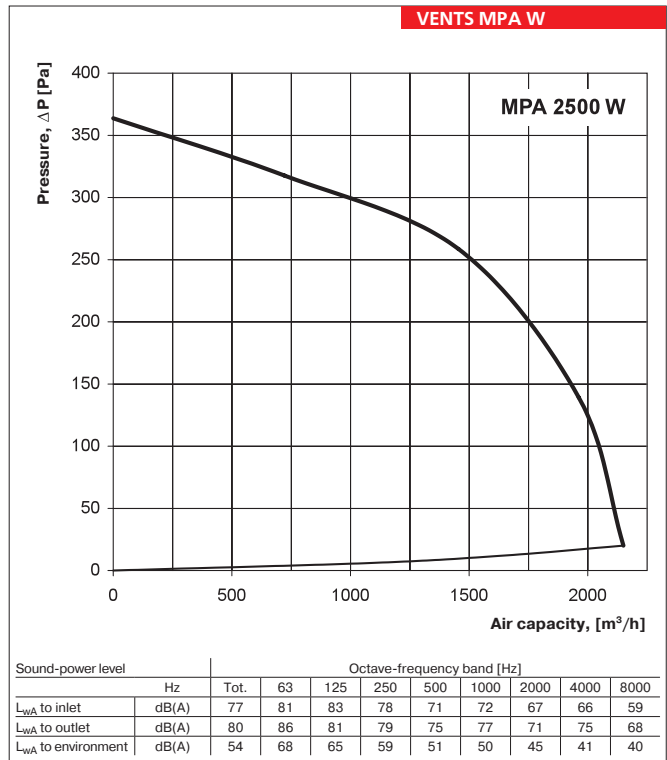
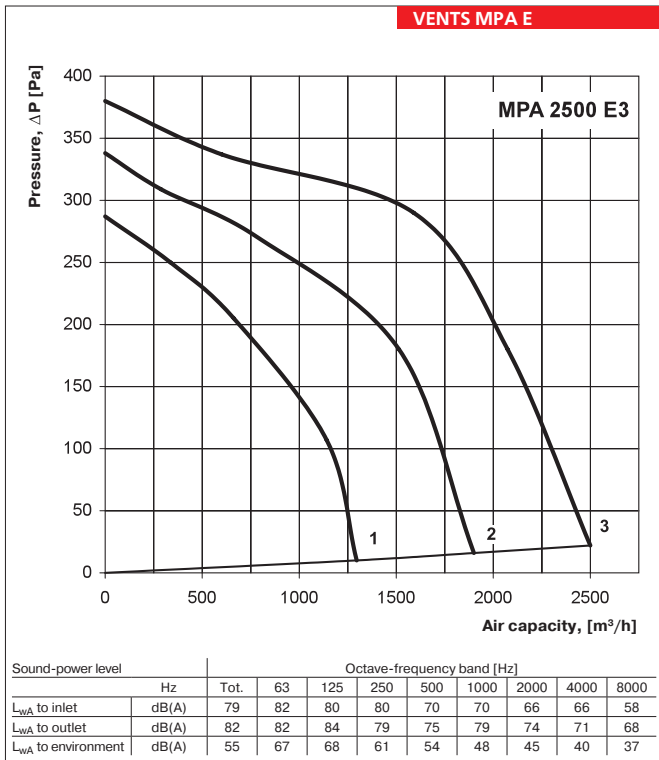

VENTS
MPA E /
MPA W

SUPPLY UNIT SERIES

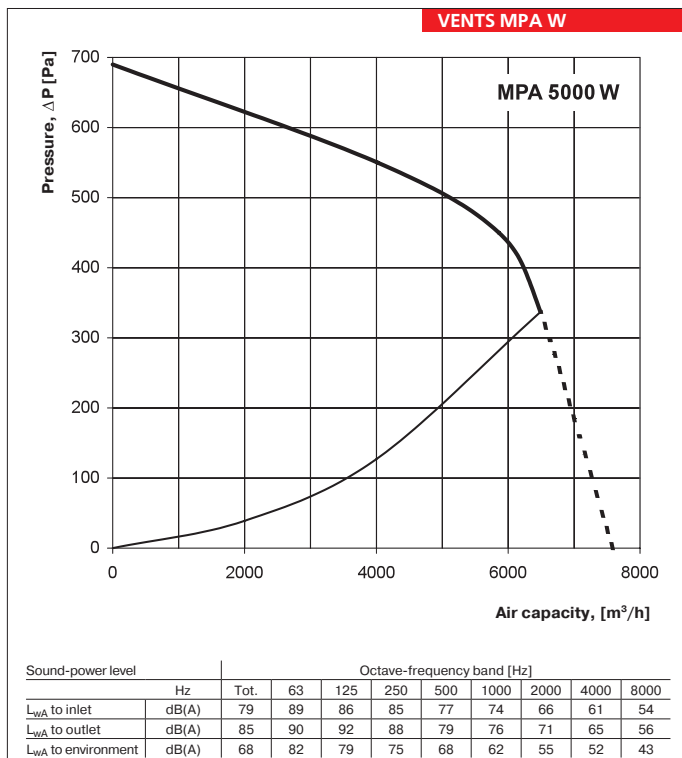
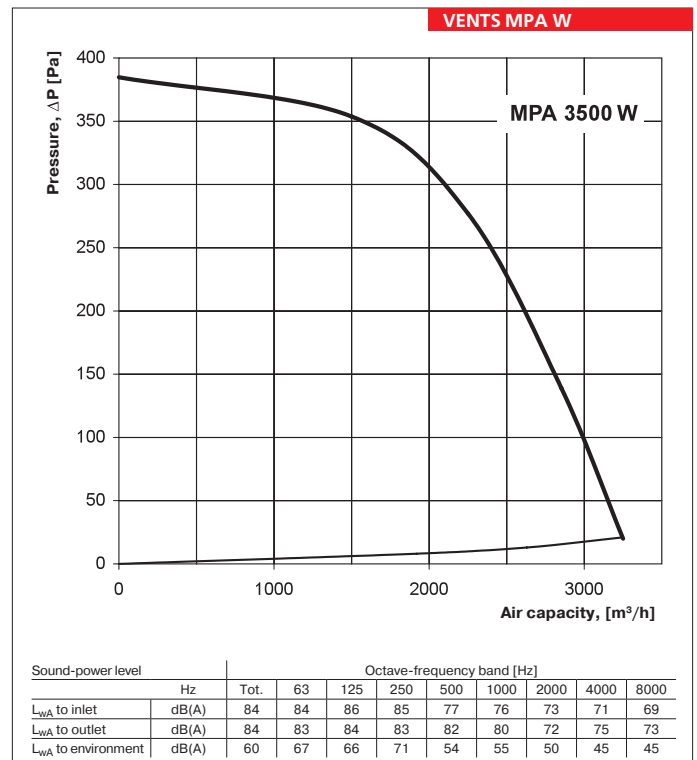
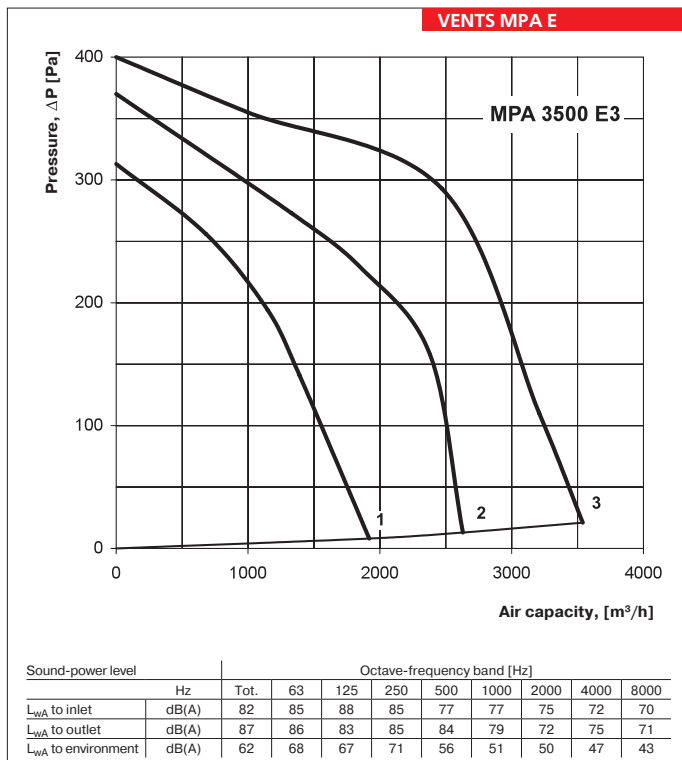

Accessories to supply units:

Type	Replaceable filter	Filter type
MPA 800 E1	SF MPA 800/1200 G4	panel filter
MPA 1200 E3		
MPA 1800 E3	SF MPA 1800/2500 G4	panel filter
MPA 2500 E3		
MPA 3200 E3	SF MPA 3200/3500 G4	panel filter
MPA 3500 E3		
MPA 800 W	SF MPA 800/1200 G4	panel filter
MPA 1200 W		
MPA 1800 W	SF MPA 1800/2500 G4	panel filter
MPA 2500 W		
MPA 3200 W	SF MPA 3200/3500 G4	panel filter
MPA 3500 W		
MPA 5000 W	SFK MPA 5000 G4	pocket filter

Office ventilation example

Air supply and exhaust ventilation in the modern office can be arranged as follows. Air handling MPA unit, exhaust fan complying with MPA unit characteristics, intake and exhaust main air ducts are mounted in the hall behind the suspended ceiling. The branchings are laid into the office premises and air distribution units.

Intake air from outside flows through the external grille, is filtered in the air handling unit, heated to the required temperature and supplied to the office rooms through the branch duct system. Exhaust air is extracted outside through the external grille by means of the exhaust fan. Thus the office has the permanent fresh air supply, controllable air exchange, no draughts when opened windows, no dust and no noise.



MPA unit office air exchange example.

Hot water coil parameters:

VENTS MPA W

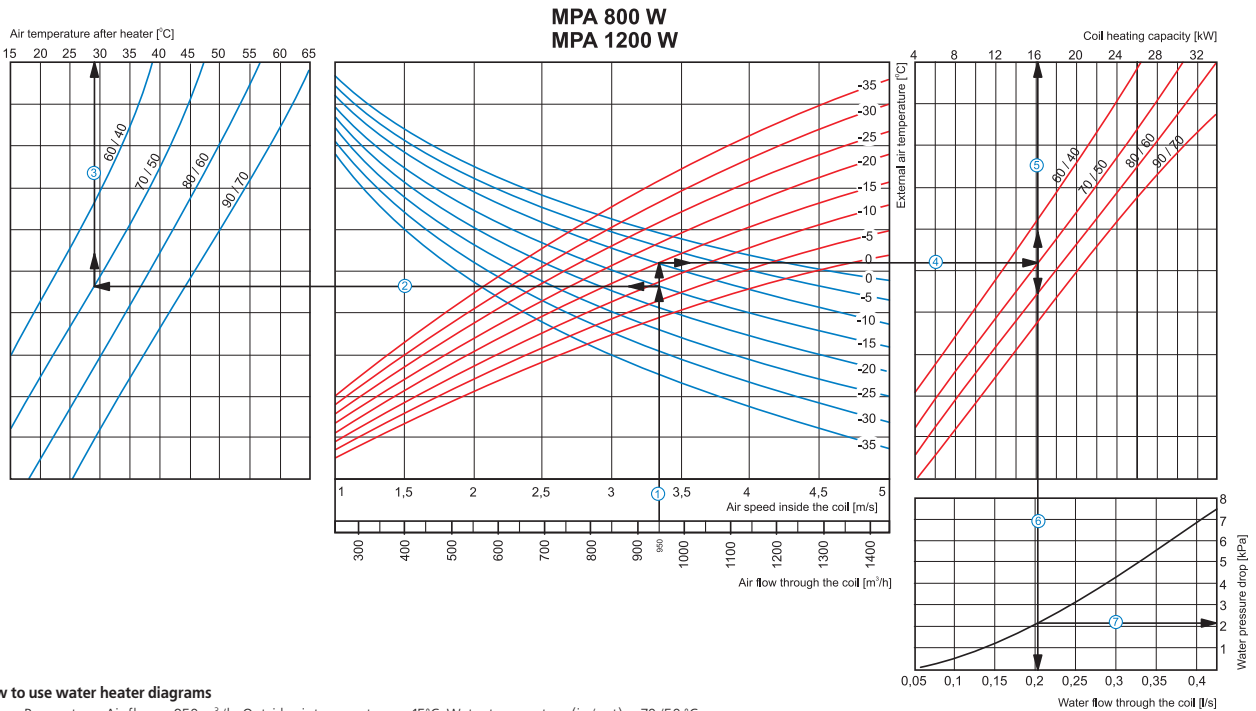

How to use water heater diagrams

System Parameters: Air flow = 950 m³/h. Outside air temperature = -15°C. Water temperature (in/out) = 70/50°C.

- Air Speed. Starting from 950 m³/h on the air flow scale draw a vertical line ① till the air speed axis which makes about 3.35 m/s.
- Supply air temperature. Prolong the line ① up to the point where it crosses the outside air temperature (blue curve), e.g. -15°C; then draw a horizontal line ② from this point to the left till crossing water in/out temperature curve (70/50°C). From this point draw a vertical line ③ to the supply air temperature axis on top of the graphic (+29°C).
- Heating coil capacity. Prolong the line ① up to the point where it crosses the outside air temperature -15°C (red curve) and draw a horizontal line ④ from this point to the right until it crosses water in/out temperature curve (70/50°C), from here draw a vertical line ⑤ up to the scale representing the heating coil capacity (16 kW).
- Water flow. Prolong the line ⑤ down to water flow axis at the bottom of the graphic ⑥ (0.2 l/s).
- Water pressure drop. Draw the line ⑦ from the point where line ⑥ crosses the black curve to the pressure drop axis. (2.1 kPa).

VENTS MPA W

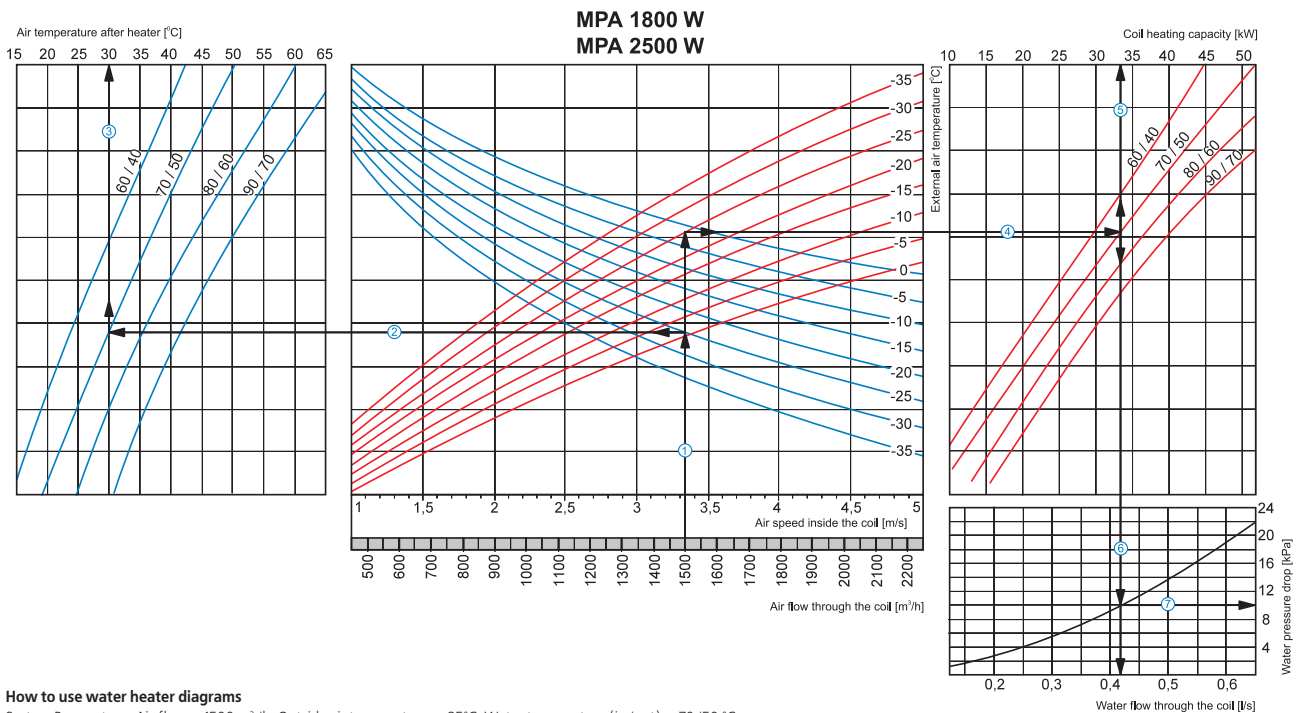

How to use water heater diagrams

System Parameters: Air flow = 1500 m³/h. Outside air temperature = -25°C. Water temperature (in/out) = 70/50°C.

- Air Speed. Starting from 1500 m³/h on the air flow scale draw a vertical line ① till the air speed axis which makes about (3.3 m/s).
- Supply air temperature. Prolong the line ① up to the point where it crosses the outside air temperature (blue curve), e.g. -25°C; then draw a horizontal line ② from this point to the left till crossing water in/out temperature curve (70/50°C). From this point draw a vertical line ③ to the supply air temperature axis on top of the graphic (+30°C).
- Heating coil capacity. Prolong the line ① up to the point where it crosses the outside air temperature -25°C (red curve) and draw a horizontal line ④ from this point to the right until it crosses water in/out temperature curve (70/50°C), from here draw a vertical line ⑤ up to the scale representing the heating coil capacity (33.0 kW).
- Water flow. Prolong the line ⑤ down to water flow axis at the bottom of the graphic ⑥ (0.42 l/s).
- Water pressure drop. Draw the line ⑦ from the point where line ⑥ crosses the black curve to the pressure drop axis. (10.0 kPa).

Hot water coil parameters:

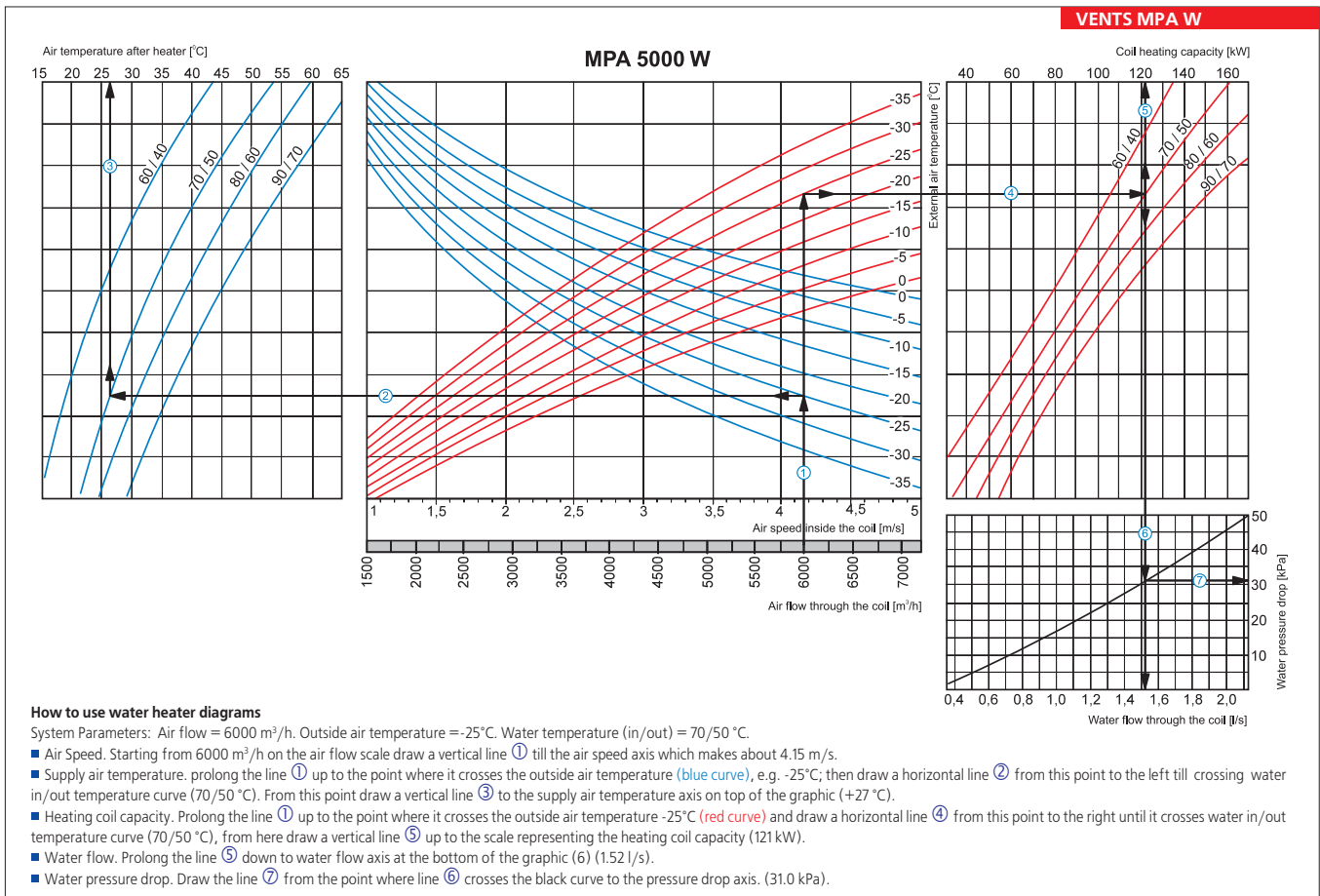
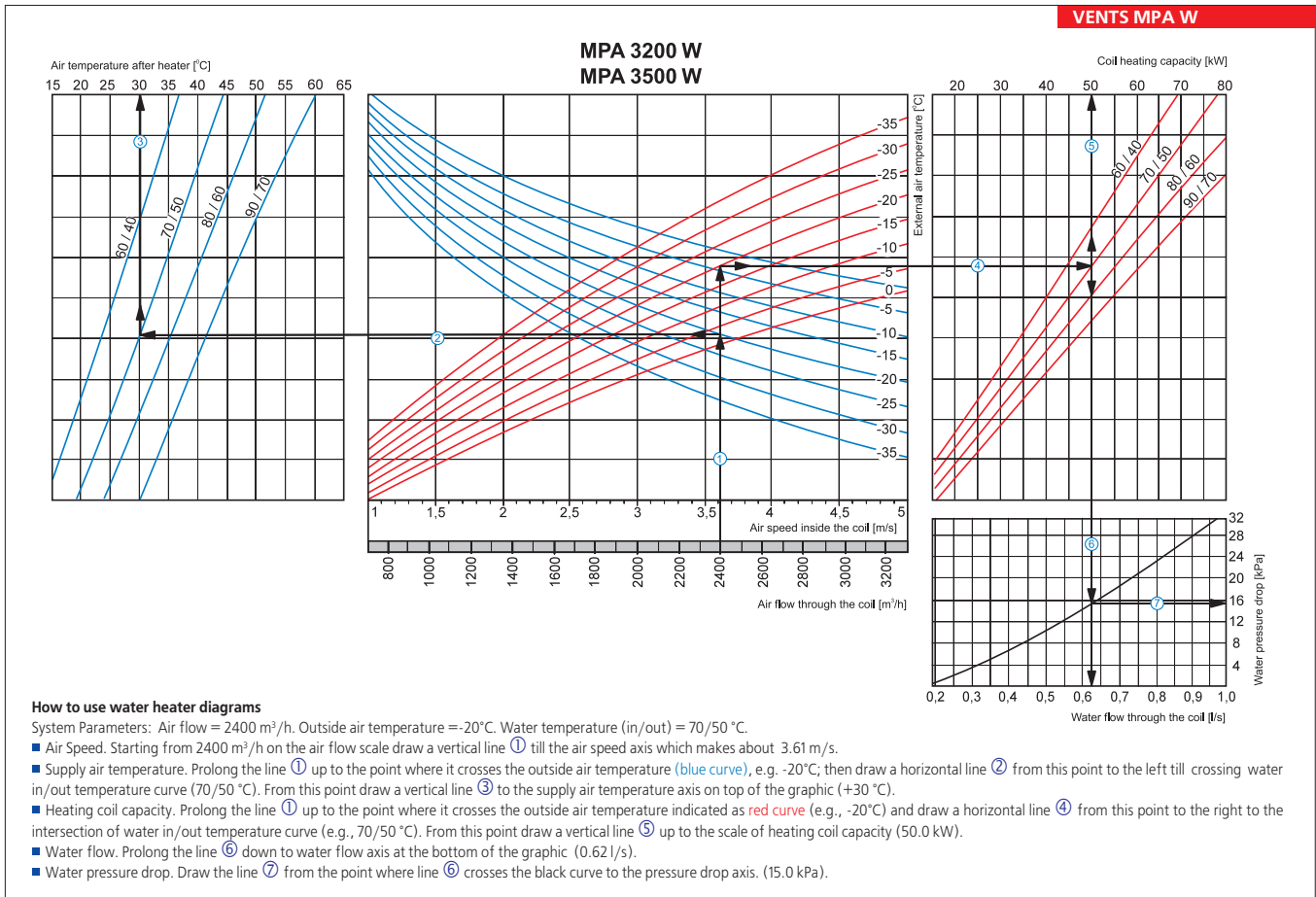

VENTS
MPA E /
MPA W

SUPPLY UNIT SERIES